

**THE C64**

&

**THE VIC 20**

**User Manual**

**RETRO  
GAMES  
410**



**THE C64**  
&  
**THE VIC 20**  
**USER MANUAL**

**RETRO  
GAMES  
LTD**

© 2021 Retro Games Ltd.  
All rights reserved.

THEC64 is a registered trademark of Retro Games Ltd. All other trademarks and copyrights are the property of their respective owners.

No part of this publication may be reproduced, stored in any retrieval system or transmitted in any form or by any means, electronic, mechanical, photocopying, recording or otherwise, without the express prior written permission of Retro Games Ltd.

Hardware, software and industrial design by Chris Smith.  
Produced and licensed by Darren Melbourne and Paul Andrews.  
Graphic design by Jen Carling.  
Games library production, testing and documentation by Richard Hewison.  
Menu music by Matt Gray.



CE — The product complies with all relevant European directives (2004/108/EC, 2006/95/EC) when installed and used in accordance with the user manual. This product can only be serviced and repaired by qualified personnel. This product has no user serviceable parts.



WEEE — The crossed-out wheelee bin symbol confirms that your product should not be disposed of with your general household waste, but should be taken to your nearest recycling center for safe and responsible disposal. This will help prevent any potential negative impact on the environment and on human health and is in compliance with current EU legislation. Please contact your local authority or retailer for further recycling advice.



The terms HDMI and HDMI High-Definition Multimedia Interface, and the HDMI logo are trademarks or registered trademarks of HDMI Licensing Administrator, Inc. in the United States and other countries.

CBM 8-Bit ROMs © 1977–1984 Cloanto® Corporation. All Rights Reserved. Furnished under license from Cloanto® Corporation. Cloanto is a trademark owned by Cloanto Corporation throughout the world and registered in the United States and internationally.

Retro Games Ltd. cannot be held responsible for any errors found in the supplied games, which were originally written and published in the 1980s or early 1990s.

Retro Games Ltd. reserves the right to change the specification of this product and the content of this manual to reflect any such changes. The latest version of the manual will always be available from the Retro Games Ltd. website at [retrogames.biz/the64/support](http://retrogames.biz/the64/support), which we encourage you to visit for warranty information, full game instructions, guides, articles and firmware upgrades.

Whilst every care has been taken to verify the accuracy of the information and links provided in this guide, we cannot be held liable or responsible for any loss, damage or inconvenience caused as a result of any inaccuracies.

THEC64 & THEVIC20 User Manual – December 2021 – Online edition

# TABLE OF CONTENTS

<b>CAUTION</b> . . . . .	vi
<b>EPILEPSY INFORMATION</b> . . . . .	vi
<b>INTRODUCTION</b> . . . . .	vii
<b>1. SETTING UP</b> . . . . .	1
• Unpacking . . . . .	2
• Connecting and Starting Up . . . . .	2
• Initial Set Up . . . . .	3
<b>2. JOYSTICK &amp; MOUSE</b> . . . . .	5
• Joystick Button Assignments . . . . .	7
• Alternative USB Controllers . . . . .	7
• Mouse (THEC64 Only) . . . . .	8
<b>3. FIRST TIME USE</b> . . . . .	9
• Set Up Questions . . . . .	10
Language . . . . .	10
Video Output . . . . .	10
Boot Mode . . . . .	11
• Switching Off . . . . .	13
<b>4. KEYBOARD</b> . . . . .	15
• Using the Keyboard in Menus . . . . .	16
• Keyboard Principles . . . . .	17
• Special Keys . . . . .	18
• VIC 20 Keys . . . . .	23
<b>5. CAROUSEL MODE</b> . . . . .	25
• Overview . . . . .	26
• Games Carousel . . . . .	27
• Game Preview . . . . .	27
• Game Information . . . . .	27
• Options Toolbar . . . . .	27
• Other Settings . . . . .	28
• Play a Game . . . . .	28
• Game Controls . . . . .	28
• Menu Options for Carousel Mode . . . . .	29

<b>6. CLASSIC MODE</b> . . . . .	33
• Overview . . . . .	34
• BASIC . . . . .	34
Virtual Blank Disks . . . . .	34
• Menu Options for Classic Mode . . . . .	35
Save/Load State . . . . .	36
Media Access . . . . .	37
Options . . . . .	37
• Saved State Location . . . . .	37
• Additional Memory . . . . .	38
<b>7. OPTIONS AND SETTINGS</b> . . . . .	39
• Boot Mode . . . . .	41
• Computer Model . . . . .	42
• Device Settings . . . . .	43
• Display Options . . . . .	43
• Exit to Carousel Mode . . . . .	44
• Factory Reset . . . . .	44
• Language . . . . .	45
• Legal Notices . . . . .	45
• Reset Computer . . . . .	46
• Shutdown Device . . . . .	46
• Switch to Classic Mode . . . . .	47
• System Information . . . . .	47
• Virtual Keyboard . . . . .	48
<b>8. LOADING OTHER PROGRAMS</b> . . . . .	49
• Introduction . . . . .	50
• Compatible File Types . . . . .	50
• Browsing Files on a USB Stick . . . . .	53
• Auto-loading Files From USB Using Default Settings . . . . .	55
What Are the Default Settings? . . . . .	56
• Fast Loader . . . . .	57
• Loading Files Using Customized Settings . . . . .	57
Filename Flags for Individual Files . . . . .	58
CJMs for Individual Files . . . . .	63
CJMs for Multiple Files . . . . .	70
Summary . . . . .	70
• Inserting Virtual Disks . . . . .	71

**9. UPGRADING** . . . . . 79

- Find Your Current Build Version . . . . . 80
- How to Upgrade Your Firmware . . . . . 80

**APPENDICES** . . . . . 83

A: TROUBLESHOOTING . . . . . 84

B: PREPARING USB STICKS . . . . . 91

C: VIC 20 COMPUTER. . . . . 94

D: ADVANCED SETTINGS . . . . . 98

E: JOYSTICK BUTTON ASSIGNMENTS . . . . . 103

## CAUTION

- Do not connect AV cables while THEC64/THEVIC20 is powered on
- Only connect USB keyboards, controllers, memory sticks and powered hubs
- Keep THEC64/THEVIC20 and all cables out of the reach of young children
- Do not position THEC64/THEVIC20 where it may cause someone to trip or stumble
- Do not power off THEC64/THEVIC20 whilst data is being loaded or saved
- Do not expose THEC64/THEVIC20 to any of the following: liquids, high temperatures, high humidity, steam, direct sunlight, excessive dust or smoke
- Do not touch THEC64/THEVIC20 or connected cables during an electrical storm
- Do not allow small particles or any foreign objects to get inside THEC64/THEVIC20
- Do not touch any of the connectors on THEC64/THEVIC20.

## EPILEPSY INFORMATION

Some games might trigger symptoms in a small number of users who suffer from or are prone to epileptic seizures or blackouts, due to the rapid color-cycling and other graphical effects employed. These effects could trigger a previously undetected condition in people with no previous history of seizures or epilepsy.

Stop using THEC64/THEVIC20 immediately and consult a doctor if you or anyone using THEC64/THEVIC20 experiences dizziness, eye or muscle twitches, disorientation, affected vision, any involuntary movements, convulsions or seizures. Only resume after taking medical advice.

To reduce the chance of experiencing symptoms associated with epilepsy:

- Use THEC64/THEVIC20 in a well-lit area and always keep a sensible distance away from the TV or monitor screen
- Avoid prolonged use of THEC64/THEVIC20. Take at least a fifteen minute break after each hour of continuous play
- Avoid using THEC64/THEVIC20 when you are tired or need sleep
- Stop using THEC64/THEVIC20 immediately if you feel tired, experience discomfort or pain in your limbs or begin to feel ill.



# INTRODUCTION

THEC64 and THEVIC20 are modern 1:1 scale versions of the classic computer systems that first appeared in 1981/1982. They are instantly reminiscent of the original design, incorporating a fully functional keyboard but with modern peripheral support via the HDMI and USB ports. These ports allow you to connect THEC64/THEVIC20 to an HD TV or monitor and connect a number of USB peripherals including additional controllers, memory sticks and powered hubs.

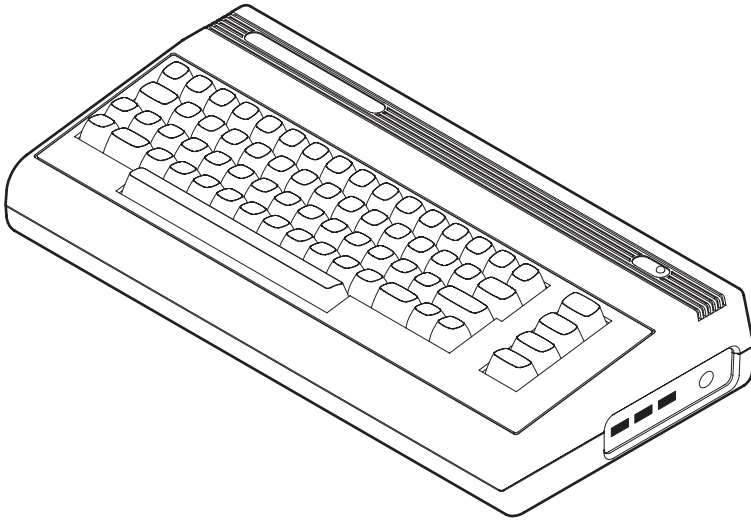

THEC64/THEVIC20 offers two modes:

- **Carousel** mode – Gives you an easy-to-use carousel with a wide selection of pre-installed C64 and VIC 20 games, ready to play
- **Classic** mode – Takes you to BASIC, ready for programming, loading and saving your programs. On THEC64 this mode also includes the ability to choose between a C64 and a VIC 20 computer model.

The two modes share many options, so if you make changes to the Display option (for example) in **Classic** mode, the change also applies to **Carousel** mode, and vice versa. You can also save a running program at any point in either **Classic** or **Carousel** mode, by using the save and load state function.

From either mode, you can load external programs using compatible files stored on a USB stick (NOT supplied). These can include virtual media files such as virtual disk, tape, cartridge and stand-alone program files. See **CHAPTER 8** for full details.

We hope you have hours of fun, either reliving your childhood or enjoying C64 or VIC 20 games for the first time!

We always recommend upgrading to the latest firmware build. Please check online at **[retrogames.biz/thec64/support/upgrade-thec64](http://retrogames.biz/thec64/support/upgrade-thec64)**

# CHAPTER 1

## SETTING UP

- Unpacking
- Connecting and Starting Up
- Initial Set Up

# UNPACKING

Before connecting anything, check the contents of the packaging:

- THEC64/THEVIC20
- USB joystick
- Quick Guide
- An HDMI cable
- A USB power cable
- A USB AC adapter.

# CONNECTING AND STARTING UP

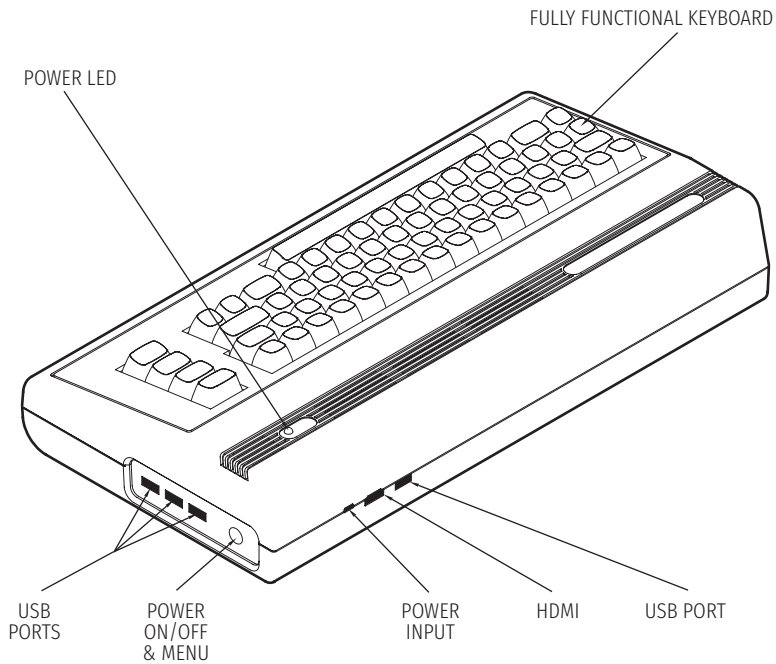

1. Ensure that your HD TV or monitor is switched OFF before you connect THEC64/THEVIC20
2. Connect the HDMI cable to THEC64/THEVIC20, and then connect the other end to your HD TV or monitor
3. Connect the joystick to a USB port on THEC64/THEVIC20
4. Plug in the power supply to an appropriate power outlet, and then connect the other end to THEC64/THEVIC20
5. Switch ON your HD TV or monitor and choose the appropriate HDMI input source
6. Press and release the POWER ON/OFF switch and the power LED glows red to confirm THEC64/THEVIC20 is now ON.

## INITIAL SET UP

THEC64/THEVIC20 asks questions about preferred settings. Using the joystick, press **FIRE** to make selections and press **⊖** (or other joystick buttons as instructed) to advance.

See **CHAPTER 3** for full details about setting up.



# CHAPTER 2

## JOYSTICK & MOUSE

- Joystick Button Assignments
- Alternative USB Controllers
- Mouse (THEC64 Only)

The USB joystick has a DIRECTIONAL STICK and eight buttons, referred to as left **FIRE**, right **FIRE**, **TL**, **TR**, **A**, **B**, **C** and **≡** (MENU).

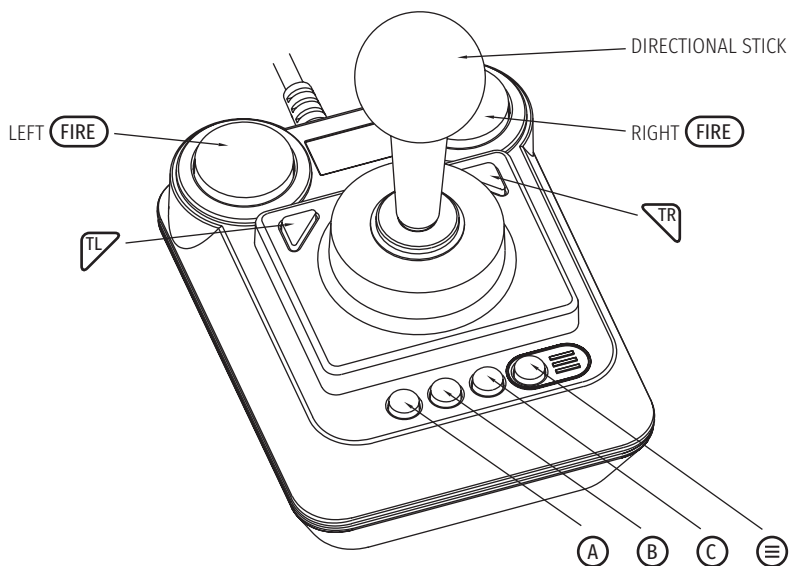

Use the joystick to:

1. Highlight and select options in the menus and screens, using the DIRECTIONAL STICK and **FIRE**. Use **≡** to leave most screens and return to the previous one, and use **A**, **B** and **C** for other functions on specific screens
2. Play the games. The supplied games in Carousel mode use some or all of the joystick buttons during play. Some games may also require using the keyboard during play. At a minimum, all games will use the DIRECTIONAL STICK and **FIRE**. See **CHAPTER 4** for further information about the keyboard, and see **CHAPTER 5** for full details about Carousel mode. See **CHAPTER 8** for details about how to configure the joystick buttons for programs loaded from a USB stick.

You always have use of **≡**, which pauses the current program, and offers a number of options via a menu.

If you prefer, you can use the keyboard to open/close the menu and highlight and select options. See **CHAPTER 4** for further information.



## JOYSTICK BUTTON ASSIGNMENTS

Joystick button assignments for the current screen appear in the bottom-left corner, showing any relevant buttons, followed by an icon for the assigned function. These do not appear on-screen whilst running a C64 or VIC 20 program.

- ○ ○ ● (☰) (or **M**, or left **SHIFT** + **←** on the keyboard, or press the power button)
- ○ ○ ○ ○ (A) (or **A** on the keyboard)
- ● ○ ○ ○ (B) (or **B** on the keyboard)
- ○ ● ○ ○ (C) (or **C** on the keyboard)

See **APPENDIX E** for a full list of joystick button assignments used on screens.

## ALTERNATIVE USB CONTROLLERS

THEC64/THEVIC20 is also compatible with a wide range of other modern USB controllers, which you use as either the primary or the secondary controller, where applicable. They need to have a minimum of eight buttons to be able to replicate the joystick's full functionality.

Using standard modern USB controller terms, joystick functions translate as follows:

Joystick	Alternative USB controller
↑, ↓, ←, → (DIRECTIONAL STICK)	Up, Down, Left, Right
Left (FIRE), Right (FIRE)	Left Trigger, Right Trigger
TL, TR	Y, X
(A), (B), (C)	A, B, Back/Guide
(☰)	Start

This information is useful if you choose to assign joystick buttons to particular functions for programs you load from a USB stick. Note that you cannot remap the (☰) button functionality.

See **CHAPTER 8** for further details on how to remap buttons when loading other programs.

## MOUSE

THEC64/THEVIC20 will detect when a USB mouse is connected and make it available to the running program as a Commodore 1351 Mouse connected to joystick port #1. However it may also connect a joystick to port #1, depending on the number of joysticks attached to the USB ports and which port is specified as the primary. See **CHAPTER 8** for further details on changing this behaviour.

# CHAPTER 3

## FIRST TIME USE

- Set Up Questions
  - Language
  - Video Output
  - Boot Mode
- Switching Off

# SET UP QUESTIONS

After switching on for the first time or after performing a factory reset, you answer a few initial set up questions.

## LANGUAGE

1. Choose which language to use for all menus

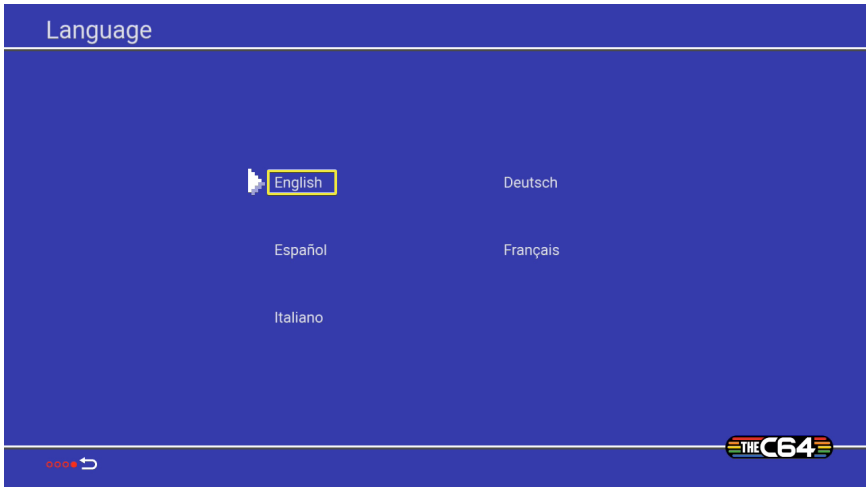

2. Move the pointer to your preferred language, press **FIRE** to confirm and then press **⌂** to advance. THEC64/THEVIC20 will remember your choice and use it automatically from now on

## VIDEO OUTPUT

3. THEC64/THEVIC20 is set to output 60 Hz by default and is the current setting. The majority of HD TVs and computer monitors accept 60 Hz. Some also accept 50 Hz. If your display can only use 60 Hz, then you don't see the Video output step. Instead, proceed to Boot mode at step 9

## Video output

For the best experience, choose the video mode that matches your region.

Enable 50Hz output - Outside North America

Enable 60Hz output - North America

press A



4. Choose the Video output option that is appropriate for your region. See **APPENDIX D** for full details about the Video output modes
5. Ensure the pointer is next to your preferred option, and then press **FIRE** to confirm
6. You are asked to press and release **A** on the Joystick or press and release **A** on your keyboard to accept your choice. Only press and release **A** if you see the on-screen instructions asking you to do this and only if you are okay to proceed with the chosen setting
7. If you see a black screen after step 5, wait ten seconds and THEC64/THEVIC20 reverts to the previous Video output setting and displays the options again. In this scenario, choose the other output mode and repeat step 6
8. Press **⏏** to advance to the next step when you are happy with the current setting

## BOOT MODE

9. THEC64/THEVIC20 asks which mode you want to use when it boots. Note that you can easily switch between the offered modes or change your preferences later on. See **CHAPTER 7** for further details

## Boot mode

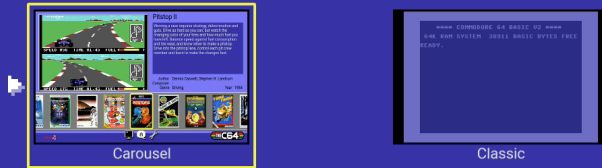



### Carousel

This mode boots into a HOME screen, giving you access to a number of pre-installed games on a CAROUSEL and offers various settings via the OPTIONS toolbar. See **CHAPTER 5** for further details about Carousel mode.

### Classic

In this mode, THEC64/THEVIC20 boots directly into BASIC. All options are available via . The version of BASIC available is dependent on the current computer model, which is set to be a C64 by default. See **CHAPTER 6** for further details about Classic mode.

10. Move the pointer to your preferred Boot mode, press  to confirm and then press  to advance. THEC64/THEVIC20 saves this setting and uses it automatically from now on. You can change this setting later if you change your mind
11. Lastly, THEC64/THEVIC20 applies all your settings and finishes booting.

## SWITCHING OFF

1. When you are ready to switch OFF, press and hold the power switch on the side for two seconds. THEC64/THEVIC20 shuts down. Alternatively, go to Device settings > Shutdown device (in Classic mode) or go to Options (spanner icon) and select Shutdown device (in Carousel mode)
2. In the unlikely event that THEC64/THEVIC20 fails to respond at any point, press and hold the power switch for approximately six seconds to force it to shut down
3. To switch THEC64/THEVIC20 back ON, press and immediately release the power switch.













# CHAPTER 4

## KEYBOARD

- Using the Keyboard in Menus
- Keyboard Principles
- Special Keys
- VIC 20 Keys

## USING THE KEYBOARD IN MENUS

When you are in menus, you can use any combination of the following keys on the keyboard to highlight and select options, in preference to using the joystick.

Key	Equivalent button action
<b>U</b>	DIRECTIONAL STICK ↑
<b>J</b>	DIRECTIONAL STICK ↓
<b>N</b>	DIRECTIONAL STICK ↓
<b>H</b>	DIRECTIONAL STICK ←
<b>O</b>	DIRECTIONAL STICK ←
<b>K</b>	DIRECTIONAL STICK →
<b>P</b>	DIRECTIONAL STICK →
<b>SPACE</b>	Left <b>FIRE</b>
<b>G</b>	Left <b>FIRE</b>
<b>RETURN</b>	Right <b>FIRE</b>
<b>L</b>	Right <b>FIRE</b>
<b>Y</b>	
<b>X</b>	
<b>A</b>	
<b>B</b>	
<b>C</b>	
Left <b>SHIFT</b> + 	 (at any time)
Power switch (single quick press-and-release)	 (at any time)
<b>M</b>	 (only when already in menus)

Note that if you select a game or program to insert or auto-load using these keyboard controls, then the game or program will only operate using the keyboard controls shown above.

When in BASIC or when running a C64 or VIC 20 program, the keyboard faithfully reproduces the functionality of the original computer keyboard for that program.

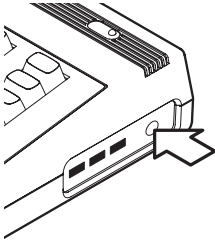

A single quick press and release of the power switch on the side of THEC64/THEVIC20 case will display or close the menu when in BASIC or running a program. If you press and hold the switch for two seconds before releasing, THEC64/THEVIC20 will shut down.

See **CHAPTER 7** for further details on all of the options and settings.

## KEYBOARD PRINCIPLES

The keyboard is similar to a modern computer keyboard, but it has some special keys that let THEC64/THEVIC20 do very specific tasks in BASIC when running as a C64 or VIC 20 computer.

### RETURN

The **RETURN** key tells the computer to look at what you typed and put this information in memory. The **RETURN** key also moves the cursor to the next line.

Note: Computer memory is where the computer stores all the information it needs to recall whilst THEC64/THEVIC20 is switched on. You can save the current memory state by using the save/load state functionality from the menu option, explained later.

### SHIFT

The **SHIFT** key works like the shift key on a regular keyboard: it lets you type capital letters or the top characters on double-character keys to the screen.

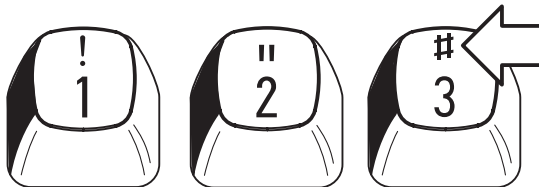

Note that in BASIC, THEC64 defaults to the upper case/graphic mode as BASIC expects all keywords to be in capitals.

When you are using the graphics on the front of the keys, the **SHIFT** key types the graphic character on the RIGHT side of the key.

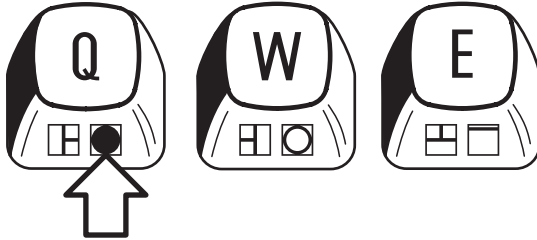

When you are using the four special function keys at the right side of the keyboard, the **SHIFT** key gives you the functions on the FRONT of the key, i.e. **f2**, **f4**, **f6**, and **f8**. Without using **SHIFT**, those keys functions are **f1**, **f3**, **f5** and **f7**.

## SHIFT LOCK

Press the **SHIFT LOCK** key and an arrow icon appears in the top-right corner of the computer screen to indicate that SHIFT LOCK is ON.



With this ON, any key you now press reacts as if **SHIFT** is pressed at the same time. Press **SHIFT LOCK** again to turn this OFF and the icon disappears.

## SPECIAL KEYS

There are two cursor keys on the keyboard:

### CRSR

**↑ CRSR ↓** moves the cursor up and down

**← CRSR →** moves the cursor left and right

You must use the SHIFT key with the **↑ CRSR ↓** key to move the cursor up, and with the **← CRSR →** key to move the cursor to the left.

You don't have to keep tapping a **CRSR** key to get it to move more than one space. Just hold it down until the cursor is where you want it.

## **INST/DEL**

**DEL** stands for DElete. When you press the **DEL** key, the cursor moves back a space and erases the character that's there, like how the Backspace key functions on more modern computers.

```
PRINT "ERROR"##  
PRINT "ERROR"█
```

When you delete in the middle of a line, first move the cursor just to the right of the character you want to delete.

```
FIX IT AGAIN$, SAM█  
FIX IT AGAIN$ SAM
```

Then press the **DEL** key. The characters to the right automatically move over to close up the space.

```
FIX IT AGAIN$ SAM
```

**INST** stands for INSerT. You have to use the **SHIFT** key with the **INST/DEL** key when you want to insert characters in a line.

If you've left some characters out of a line, use the **CRSR** keys to move the cursor back to the error.

```
WHILE U WERE OUT█  
WHILE U WERE OUT
```

Then, while you hold down the **SHIFT** key, press the **INST/DEL** key until you have enough space to add the missing characters. **INST** doesn't move the cursor; it adds space between the cursor and the character to its right.

```
WHILE ■ U WERE OUT
WHILE YOU WERE OUT
```

Use the **DEL** and **INST** keys together to fix wrong characters.

```
WE 'RE NUMBER TWO
WE 'RE NUMBER 
WE 'RE NUMBER ■ !
WE 'RE NUMBER ONE
```

## CLR/HOME

**HOME** moves the cursor back to the upper left corner of the screen. This is called the 'HOME' position.

**CLR** stands for CLear. When you use the **SHIFT** key with the **CLR/HOME** key, the screen clears and the cursor returns to the 'HOME' position.

## RESTORE

The **RESTORE** key returns the computer to its normal state by restoring the default conditions (e.g., the default C64 screen color is blue, etc.) **RESTORE** does such things as clear the screen, returning it to the original color, and turn off the picture- and sound-making chips.

NOTE: For **RESTORE** to work in BASIC as described, hold down the **SHIFT** and **RUN/STOP** keys on THEC64 keyboard while you press the **RESTORE** key. This action is only possible using THEC64 keyboard, not the Virtual keyboard explained in **CHAPTER 7**.

For example, suppose you've just played a music program that also turned your screen red and yellow while it LISTed the program. When you press **SHIFT**, **RUN/STOP** and **RESTORE** at the end of the program, the last note from the program will cease, your screen will return to its normal colors and the only thing displayed will be the READY prompt.

## CTRL

The ConTRol key lets you set colors and do other special tasks called control functions.

To set colors, hold down the **CTRL** key while you press the key with the color you want. In C64 BASIC you can get eight more colors than in VIC 20 BASIC by using the **THE C64** key. See later for more details.



To get a control function, hold the **CTRL** key down while you press the other key. Control functions are commonly used in software such as word processing systems.

## RUN/STOP

You can halt a BASIC program while it is still RUNning by pressing the **STOP** key.

**RUN** lets you load a program automatically from a cassette file (tap). When you want to use the **RUN** key, you must also use the **SHIFT** key. This action is only possible using the keyboard, not the Virtual keyboard explained in **CHAPTER 7**.



The **THE C64** or **THE VIC 20** key can do two things:

1. Switch back and forth between the upper and lower case display mode (the letters and characters on the tops of the keys) and the upper case/graphic display mode (capital letters and the graphics on the fronts of the keys).

To switch modes, press **THE C64/VIC 20** and **SHIFT** keys at the same time on the keyboard.

When you first enter BASIC, THEC64/THEVIC20 is in the upper case/graphic mode, which means that everything you type in is in capital letters. When you are in this mode, you can also print all the graphics on the fronts of the keys.

To print the graphic on the right side of a key, hold down the **SHIFT** key while you press the key with the graphic you want to print. You can only print the right side graphics when you are in the upper case/graphic mode.

To print the graphic on the left side of a key, hold down **THE C64** / **DISK II** while you press the graphic key. You can print the left side graphic in either mode.

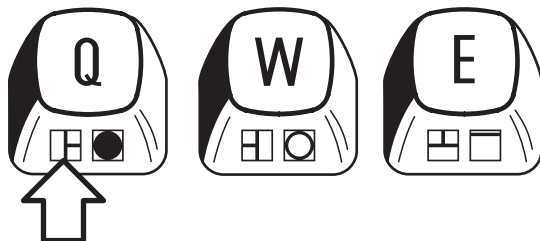

2. **THE C64** also lets you use the second set of eight alternate colors not shown on the color keys when in C64 BASIC. To get these other colors, hold down **THE C64** while you press and release the number for the color you want.

**1-ORANGE**

**2-BROWN**

**3-LIGHT RED**

**4-GRAY 1**

**5-GRAY 2**



**6-LIGHT GREEN**

**7-LIGHT BLUE**

**8-GRAY 3**



## VIC 20 KEYS

A C64 and a VIC 20 computer share the exact same keyboard layout. However, there are a few differences between the computer models when using some of the keyboard functionality. For example, you don't get the second set of eight colors mentioned previously when using /  in VIC 20 BASIC, as the VIC 20 computer has less colors available.

1-BLACK	5-PURPLE
2-WHITE	6-GREEN
3-RED	7-BLUE
4-CYAN	8-YELLOW

See **CHAPTER 7** for details on how to change to the VIC 20 computer model and see **APPENDIX C** for further details about using the VIC 20 computer.

**Visit the Retro Games Ltd. web site for further details about programming in BASIC.**



# CHAPTER 5

## CAROUSEL MODE

- Overview
- Games Carousel
- Game Preview
- Game Information
- Options Toolbar
- Other Settings
- Play a Game
- Game Controls
- Menu Options for Carousel Mode

# OVERVIEW

Carousel mode gives you instant access to a collection of pre-installed and pre-configured games. Just select a game and start playing!

**To use the joystick in Carousel mode, connect it at any point *before* you launch a pre-installed game, otherwise the joystick won't be available during play.**

The HOME screen is where you choose which one of the pre-installed games to play and where you access configuration options.

To get back to the HOME screen when running any game, press  and select 'Exit game' from the menu.



OPTIONS TOOLBAR  
(DISPLAY, LANGUAGE, SETTINGS, FILE LOADER)

## GAMES CAROUSEL

Use ↑/↓ to move the highlight between the GAMES CAROUSEL and the OPTIONS TOOLBAR. Wherever you are on the HOME screen, ←/→ chooses an option, and **FIRE** makes a selection.

## GAME PREVIEW

This window shows preview images from the highlighted title in the GAMES CAROUSEL.

## GAME INFORMATION

This window displays information about the highlighted title, giving a summary of the game, the type of game and who created it.

## OPTIONS TOOLBAR

Choose from Display, Language, Settings and (if a prepared USB stick is connected) File loader options.

To choose an option, move ←/→ and press **FIRE**. Press **≡** to leave the current screen. See **CHAPTER 7** for full details on all the settings.

The **File loader** icon appears in the OPTIONS TOOLBAR when you connect a FAT32 formatted USB stick to a USB port. Use this option to load other C64 and VIC 20 compatible program files from a USB stick, using a virtual disk, tape, cartridge or stand-alone program.

See **APPENDIX B** for full details on how to prepare a USB stick for use on THEC64/THEVIC20, and see **CHAPTER 8** for full details on using the File loader.

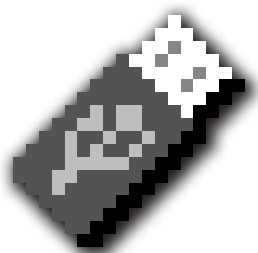

## OTHER SETTINGS



Press **A** (or **A** on the keyboard) to sort the games on the GAMES CAROUSEL in a different order. This setting saves when you switch to Classic mode or when THEC64/THEVIC20 is shutdown. The default is set to sort by title.



Press **C** (or **C** on the keyboard) to toggle the menu music off and on. This setting saves when you switch to Classic mode or when THEC64/THEVIC20 is shutdown. The music is on by default.

## PLAY A GAME

Push ←/→ to step through the games displayed by the GAMES CAROUSEL on the HOME screen.

The GAME PREVIEW and GAME OVERVIEW windows on the HOME screen give you a summary of the highlighted game.

Press **FIRE** to launch the highlighted game. Note that THEC64 assigns the joystick that selects the game from the CAROUSEL as the primary joystick for that game, typically used by player 1 in most games. Note that VIC 20 games only use one joystick.

## GAME CONTROLS

The majority of the CAROUSEL games use the DIRECTIONAL STICK ←/→/↑/↓ and **FIRE** to play. Some games make use of the additional buttons on the joystick.

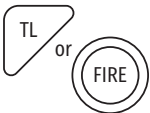

**Visit the Retro Games Ltd. website for full instructions for each title on the CAROUSEL.**

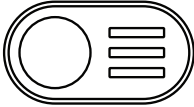

Most games use the **TL** button on the joystick to start playing. If that doesn't start the game, try **FIRE** instead, or refer to any on-screen instructions in the game.

## MENU OPTIONS FOR CAROUSEL MODE



Pressing  during gameplay temporarily suspends the game and reveals the menu options for Carousel mode. Press  again to return to the current program.



↑  
MENU OPTIONS

Use ←/→ to highlight a menu option, and then press  to confirm your selection.

## SAVE/LOAD STATE

Use this to save the current computer state, or load a previously state so you can continue to play from that position. Each game has four slots available, and each slot can be overwritten at any time with a different save.



Use ←/→ to highlight a slot.



Press **(A)** (or **A** on the keyboard) to save to the highlighted slot.



Press **(C)** (or **C** on the keyboard) to load from the highlighted slot.



Press **(≡)** (or **M** or left **SHIFT** + **←** on the keyboard) to return to the game.

**After a save or load, the menu closes automatically and the game instantly resumes play.**



## VIRTUAL KEYBOARD



Some games require you to press keys during play, e.g. when entering names into a high score table or selecting options from a menu.

Use the keyboard to press these keys, or use the Virtual keyboard option to reveal an on-screen keyboard you control using the joystick.



If using the Virtual keyboard, press  (or **M** or left **SHIFT** +  on the keyboard) when you're finished to close it and instantly restore control to the current game.

See **CHAPTER 7** for further details about the Virtual keyboard.

## EXIT GAME



To quit the current game and return to the HOME screen, select this option. To keep your progress, make sure you have used the Save/load state option first.



# CHAPTER 6

## CLASSIC MODE

- Overview
- BASIC
  - Virtual Blank Disks
- Menu Options for Classic Mode
  - Save/Load State
  - Media Access
  - Options
- Saved State Location
- Additional Memory

# OVERVIEW

In Classic mode, THEC64/THEVIC20 boots into the current computer model (a C64 by default on THEC64, a VIC 20 on THEVIC20) and puts you into BASIC, just like the original computer.

Please note that the 60 Hz Video output mode sets the default computer model to NTSC. If you are able to choose 50 Hz, then the default computer model is set to PAL. On THEC64 you can easily change the computer model via the Device settings option in the menus. See **CHAPTER 7** for further details on all of the options and settings.

# BASIC

**BASIC** (Beginners All-purpose Symbolic Instruction Code) was created in the early 1960s, and different versions were developed for a variety of computers over the next few decades.

In the late 1970s and early 1980s, it was important that all computer owners learned how to write computer programs. As a result, almost all computers booted directly into a programming language (typically a version of BASIC) when switched on. Booting to Graphical User Interfaces (GUIs) like the original Macintosh OS and Microsoft Windows came later.

## VIRTUAL BLANK DISKS

When you launch BASIC, THEC64/THEVIC20 automatically looks for a connected USB stick. If it finds one, then it looks to see if a compatible virtual disk file named THEC64-drive8.d64 is present in the root of the stick. If the file is absent, then THEC64/THEVIC20 creates one for you and inserts it the next time BASIC launches, ready for saving and loading programs.

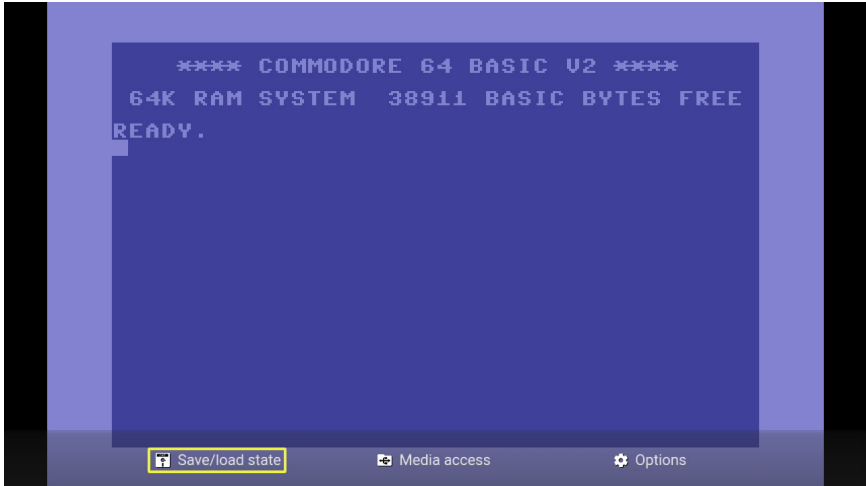

See **CHAPTER 8** for further details on using virtual disks and the various other types of file compatible with THEC64/THEVIC20. Also, see **APPENDIX B** for further details about preparing a USB stick for use on THEC64/THEVIC20.

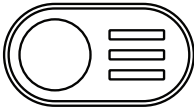

MENU OPTIONS

## MENU OPTIONS FOR CLASSIC MODE



Access a number of options by pressing  whilst you are in BASIC or running a program. A menu appears at the bottom of the screen and the current computer pauses. Press  again to return to the current program or BASIC.

From the menu, you can insert or auto-load virtual media files, change to a different computer model, amend settings for the display, upgrade THEC64's/THEVIC20's firmware, and much more.

**Please note that the same group of options are available from the MENU regardless of which computer model is currently in use.**

## SAVE/LOAD STATE

Use this option to save or load the computer's current state. THEC64/THEVIC20 allocates four save slots for each program that you load and run.



Each used slot shows a thumbnail of the moment the state saved. In the bottom-right corner of each used slot is a timestamp. This indicates how long the computer model was running when that state saved, measured in minutes.

Please be aware that saving to a used slot automatically overwrites the existing state with a new version.

- Use ←/→ to highlight a slot
- Press **A** (or **A** on the keyboard) to save to the highlighted slot.
- Press **C** (or **C** on the keyboard) to load from the highlighted slot.
- Press **≡** (or **M** or left **SHIFT** + **←** on the keyboard) to return to the computer and resume the current program

**After a successful save/load, the menu closes and the current program resumes automatically.**

## MEDIA ACCESS

Load compatible programs from a connected USB stick using this option. Access virtual disks, tapes, cartridges and standalone programs and then choose to insert or auto-load them into the current computer.

See **CHAPTER 8** for further details about the Media access option and saved states.

## OPTIONS

There are a number of options to choose from here, which configure a range of different functions. See **CHAPTER 7** for further details on all of the options and settings on THEC64/THEVIC20.

## SAVED STATE LOCATION

If you are running a program loaded from a USB stick (see Media access), then the state saves to the USB stick, otherwise it saves directly to THEC64/THEVIC20. The state always saves to THEC64/THEVIC20 if no suitably formatted USB stick is connected at the time the save is started.

The very first time THEC64/THEVIC20 saves on a USB stick, it creates a special folder on the USB stick named `.THEC64SAVE`. Inside that folder, THEC64/THEVIC20 creates another folder, named after the virtual media file that contains the program currently running. For example, `/.THEC64SAVE/mydisk_M6` contains any saved state files for programs loaded from the virtual disk file `mydisk_M6.d64`.

Please note that you cannot browse to the `.THEC64SAVE` folder on THEC64/THEVIC20, and some desktop computer systems hide this folder from view if you were to connect the USB stick to another computer and browse from there.

See **CHAPTER 8** for further information about loading programs from a USB stick, and for additional details relating to saved state files.

## ADDITIONAL MEMORY

THEC64/THEVIC20 supports additional RAM for both the C64 and VIC 20, adding between 512 kB and 16 MB for the C64 and between 3 kB and 35 kB for the VIC 20 model.

Where as it is rare for a C64 program to require additional memory, this is frequently not the case for the VIC 20 which by default had very little RAM. Many VIC 20 programs require a memory expansion to run correctly, or at all. Matters are slightly complicated by the existence of several different expansion schemes, so it is important to select the one expected by the program. Giving too much memory to a VIC 20 program will often fail.

As a general rule, VIC 20 games which require 8 kB will usually work with 8 kB, 16 kB or more RAM. Unexpanded VIC 20 games and >3 kB games will often both work with 3 kB of additional memory.

For most C64 users and games, 64 kB of RAM was perfectly sufficient. However, Commodore released the Commodore Ram Expansion Unit (REU) in the mid 1980s, adding between 128 kB and 512 kB of RAM, and some software was subsequently written to make use of it.

REU support in THEC64 has been available since firmware version 1.5.2 and allows either 512 kB, 2 MB or 16 MB of memory expansion.

Although the vast amount of C64 software available does not require REU memory, there is some very good productivity software and other applications, as well as a small number of games and demos, that do support it.

Additional memory options for the VIC 20 and C64 are discussed in **CHAPTER 8**.



# CHAPTER 7

## OPTIONS AND SETTINGS

- Boot Mode
- Computer Model
- Device Settings
- Display Options
- Exit to Carousel Mode
- Factory Reset
- Language
- Legal Notices
- Reset Computer
- Shutdown Device
- Switch to Classic Mode
- System Information
- Virtual Keyboard

**Carousel** mode and **Classic** mode share many of the same options and settings. This chapter details them in *alphabetical order*. Some settings are only available in one mode, and where and how you access the shared settings may differ between the modes.

Note that if you change a shared setting in one mode, that setting also applies to the other. For example, change the language to Français in Carousel mode and it also changes the language to Français in Classic mode.

## SELECTING OPTIONS AND SETTINGS

**Carousel** mode    Select various icons from the Options Toolbar, below the GAMES CAROUSEL on the HOME screen

**Classic** mode    Press  and then choose Options from the menu

## BOOT MODE >

The mode you want THEC64/THEVIC20 to use when it switches on.

You can easily switch between the two modes after booting THEC64/THEVIC20.

See **CHAPTER 5** for further details about Carousel mode.

See **CHAPTER 6** for further details about Classic mode.

You can load programs from a USB stick in either mode. See **CHAPTER 8** for full details.

## CAROUSEL MODE

This mode boots into a HOME screen, giving you access to a number of pre-installed games on a CAROUSEL as well as various settings via an OPTIONS toolbar.



## CLASSIC MODE

In this mode, THEC64/THEVIC20 boots directly into the current computer's BASIC (C64 example shown below). All options are available via .

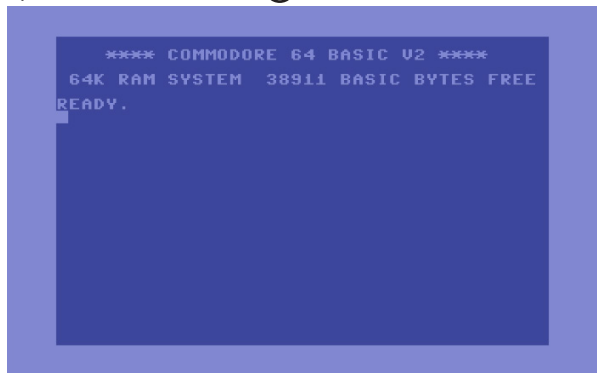

## COMPUTER MODEL>

The computer model to use whilst in Classic mode.

*Current model* (Classic mode only) shows what the current computer model is set to. This is affected by any filename flags or CJM files on programs currently loaded from a USB stick. You can change this model setting from here. See **CHAPTER 8** for more details on CJM files and filename flags.

*Default model* shows which computer model to use when THEC64/THEVIC20 next boots into Classic mode, or when you switch to Classic mode from Carousel mode. You may change this setting from here.

See **CHAPTER 8** for details about file compatibility for each computer model.

See **APPENDIX C** for further details about the VIC 20 computer model.

You have a choice between a PAL or NTSC model for each computer and for the **Current** or **Default** setting:

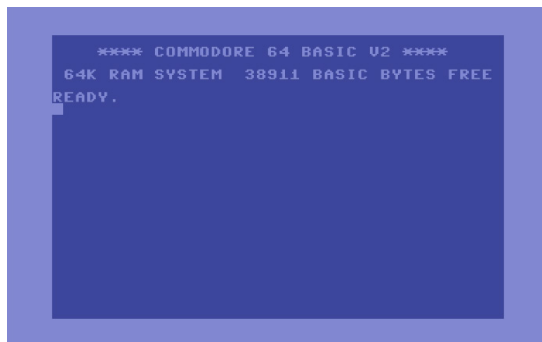

### C64

The default computer on THEC64 is the C64, which runs C64 programs and has approximately 38 kB of memory available to BASIC.

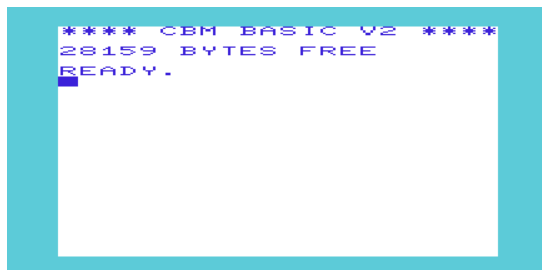

### VIC 20

This is the predecessor to the C64, and is the default computer on THEVIC20 and is available as an option on THEC64. The VIC 20 has different video and audio capabilities and less available memory than the C64.

An unexpanded VIC 20 has approximately 3.5 kB of memory available to BASIC. Add expanded memory using CJM or filename flags for programs requiring more memory. The VIC 20 only has one joystick port and it can only run VIC 20 programs.

## DEVICE SETTINGS>



This takes you to a screen with the various Device settings options.

Each option is detailed in this chapter.

**Computer model>**

**Boot mode>**

**Legal notices>**

**System information>**

**Shutdown device>**

**Factory reset>**

## DISPLAY OPTIONS>



Change how the games display on your HD TV or monitor.

For best results, set your TV Aspect to Auto to preserve the aspect ratio of THEC64/ THEVIC20. We recommend not using 4:3, 16:9 or any zoom modes.

This is not the same as the Video output setting, which you configure as either 60 Hz (default) or 50 Hz.

See **APPENDIX D** for further details about the Video output modes.

Customization settings using filename flags or CJM files let you vertically shift the display or use a full height mode for programs loaded from a USB stick. See **CHAPTER 8** for further details.

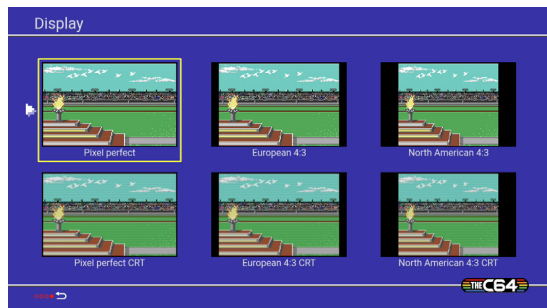

### PIXEL PERFECT

This mode gives a fuller display width, with square pixels (C64) or pixels at 2:1 ratio (VIC 20)

### EUROPEAN 4:3

This mode reproduces the display width of the original European computer

### NORTH AMERICAN 4:3

This mode reproduces the display width of the original North American computer.

You can also choose an additional **CRT** mode to introduce a softer, scanline effect, should you want the games to look as if they are displaying on an old TV display.

## EXIT TO CAROUSEL MODE

(only in **Classic** mode)

Selecting this option exits to Carousel mode, displaying the HOME screen.

The current computer's state in Classic mode is not saved when you exit to Carousel mode, so save if you need to before you exit.

See **CHAPTER 5** for further details about Carousel mode.



## FACTORY RESET➤

This permanently erases any saved settings (e.g. Display, Language, Boot mode) and reverts to their defaults.

A factory reset also erases any saved states stored on THEC64/THEVIC20. It does not erase saved states for programs stored on a USB stick.

See **CHAPTER 8** for details about loading other programs from a USB stick.

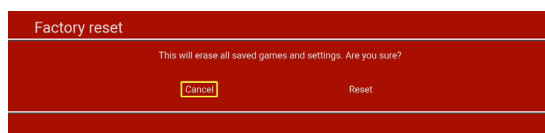

## CANCEL

This is the default option.

## RESET

Highlight the 'Reset' option and press **(FIRE)** to confirm. Only select this option if you are sure you want to reset THEC64/THEVIC20.

## LANGUAGE >

Choose which language to use for all menus and screens.

To change the current setting, move the pointer to your preferred language and press **FIRE** to confirm.

Press **⊙** to advance. THEC64/THEVIC20 saves your choice automatically.

Please note that this does not change the language used in the supplied games in Carousel mode, which is English.

## LEGAL NOTICES >

This option presents a collection of legal notices and Intellectual property (IP) information.

Push **↑/↓** to step through the various pages.

### ENGLISH

This is the default setting. All menus and screens will feature English language text.

### DEUTSCH

All menus and screens will feature German language text.

### ESPAÑOL

All menus and screens will feature Spanish language text.

### FRANÇAIS

All menus and screens will feature French language text.

### ITALIANO

All menus and screens will feature Italian language text.

### IP NOTICES

Lists information relating to the people who worked on THEC64/THEVIC20, and the legal IP owners of the officially licensed game files and computer system ROMS included in the firmware.

### LICENSES

Details of all the various licenses for code included on THEC64/THEVIC20.

# RESET COMPUTER

(only in **Classic** mode)

This resets the current computer model and returns it to BASIC without any programs retained in memory.

The reset is instant.

Note that any inserted media (e.g. virtual disk, tape or cartridge) remains inserted after a reset until you eject it or replace it with a different virtual media file of the same type. This means the saved states for the last inserted media also remain available via the menu until the media is ejected or replaced.

For virtual cartridge files, eject them before selecting the reset computer option, else the cartridge auto-boots after the reset. This does not apply for PRG, P00 or T64 files allocated to the cartridge slot by THEC64/THEVIC20.

See **CHAPTER 8** for further details on ejecting media.

# SHUTDOWN DEVICE>

This option shuts down THEC64/THEVIC20, which is the same as pressing and holding the POWER button for two seconds.

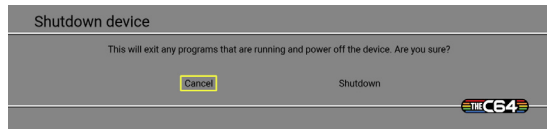

## CANCEL

This is highlighted by default.

## SHUTDOWN

Highlight the option and press **FIRE**. THEC64 shows 'Shutting down...' before powering off.

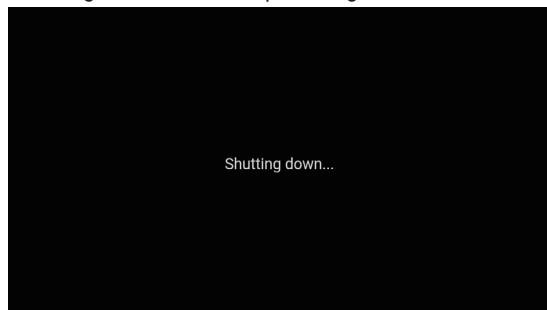



## SWITCH TO CLASSIC MODE

(only in **Carousel** mode)

This option immediately switches to Classic mode, entering BASIC.

See **CHAPTER 5** for further details about Classic mode.



## SYSTEM INFORMATION >

This option reveals the current firmware build and the current Video output mode (50 Hz or 60 Hz).

Connect a correctly formatted USB stick containing an official firmware upgrade file to a USB port and you will see the upgrade option on this screen.

See **APPENDIX B** for further details about formatting USB sticks.

See **CHAPTER 9** for further details about how to upgrade the firmware.

**You cannot install an earlier firmware than the build version currently installed.**

## CLOSE

If there is no firmware upgrade file available, this is the only option here.

If there is a valid firmware upgrade file detected on an connected USB stick, you have two choices:

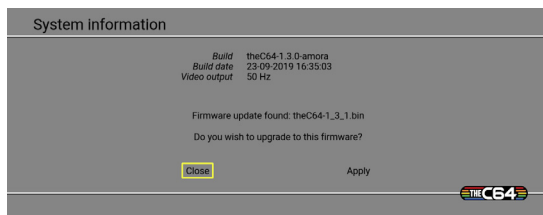

## CANCEL

This is the default option.

## UPGRADE

This will upgrade your firmware to the latest version. All saved settings are unaffected by an upgrade.



Do not disconnect the USB stick whilst an upgrade is in progress.

## VIRTUAL KEYBOARD

Using the joystick, the virtual keyboard gives access to all the keys of an original C64 computer but from an on-screen interface.

The C64 and VIC 20 computer models share the exact same keyboard layout, and so have the same virtual keyboard.

Note that the virtual keyboard can only send one key press at a time, so if pressing keys simultaneously or rapidly pressing keys is required, then use the physical keyboard instead.

Move the selector box over the keys and press **FIRE** to send that key press to the computer.

**TL**: Jump to the next virtual keyboard section (there are three).

**TR**: Press the virtual **SPACE** key.

**A**: Press the virtual **RETURN** key.

**C**: Press the virtual **INST/DEL** key.

**≡**: Quit the virtual keyboard and return control to the current computer.

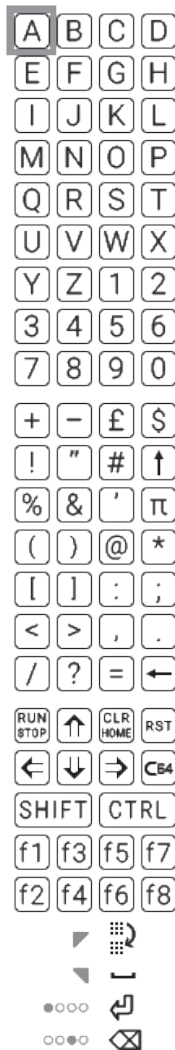

# CHAPTER 8

## LOADING OTHER PROGRAMS



- Introduction
- Compatible File Types
- Browsing Files on a USB Stick
- Auto-loading Files from USB Using Default Settings
  - What Are the Default Settings?
- Fast Loader
- Loading Files Using Customized Settings
  - Filename Flags for Individual Files
  - CJMs for Individual Files
  - CJMs for Multiple Files
  - Summary
- Inserting Virtual Disks



# INTRODUCTION

Load programs for the C64 or the VIC 20 from a USB stick connected to THEC64/THEVIC20. The USB stick needs formatting as FAT32 (with MBR) before you begin, and you provide the USB stick and the compatible files. See **APPENDIX B** for further details about preparing a USB stick for use.



# COMPATIBLE FILE TYPES

What type of files work on THEC64/THEVIC20?

File extension	Details	Icon	Computer model(s)
d64	A virtual disk file, e.g. mydisk.d64.  Classic mode only: If a blank virtual disk file called thec64-drive8.d64 is not in the root of the USB stick, then THEC64/THEVIC20 creates and inserts one for you. This empty virtual disk file can be used for saving and loading programs if required, or ejected or replaced with a different virtual disk file.		C64, VIC 20
g64	A virtual disk file with extra disk information, e.g. protected.g64.		C64
d81	A virtual disk file with greater storage capacity than a d64, e.g. compilation.d81.		C64

File extension	Details	Icon	Computer model(s)
d82	A virtual disk file with greater storage capacity than a d64, e.g. collection.d82.		C64
crt	<p>A virtual cartridge file for almost instant loading, e.g. quickload.crt.</p> <p>A VIC 20 virtual cartridge file with a prg file extension needs renaming with a crt file extension if it is to work on THEC64. See <b>APPENDIX C</b> for further details about the VIC 20.</p>		C64, VIC 20
tap	<p>A standard virtual tape file, used to store programs, e.g. slowloader.tap.</p> <p>Note that tape can be the slowest method available, taking several minutes to load a tape file. Tape files may be auto-loaded, which is the easiest way to load the first (and quite often the only) program on a tape, or (as of firmware version 1.4.1) they can be inserted into the virtual Datasette drive and navigated in a similar fashion as to how one would on an original C64 or VIC 20. See <b>USING VIRTUAL TAPES AND DATASETTE CONTROLS</b> for further details.</p>		C64, VIC 20

THEC64/THEVIC20 also auto-loads the following special files, as if they are virtual cartridges:

File extension	Details	Icon	Computer model(s)
t64	<p>A container that stores stand-alone virtual program files, e.g. <code>game.t64</code>.</p> <p>t64 files are auto-loaded on THEC64/THEVIC20. Media access (in Classic mode) places these in the cartridge slot.</p>		C64
prg	<p>A stand-alone virtual program file, e.g. <code>game1.prg</code>.</p> <p>These files are auto-loaded on THEC64/THEVIC20. Media access (in Classic mode) places these in the cartridge slot.</p> <p>Some prg files for VIC 20 are part of a set from a cartridge, and these must have a crt file extension to work as a cartridge on THEC64/THEVIC20. See <b>APPENDIX C</b> for further details about the VIC 20.</p>		C64, VIC 20
p00	<p>A compressed stand-alone virtual program file, e.g. <code>game2.p00</code>.</p> <p>These files are auto-loaded on THEC64/THEVIC20. Media access (in Classic mode) places these in the cartridge slot.</p>		C64, VIC 20

## BROWSING FILES ON A USB STICK

Connect your prepared USB stick to THEC64/THEVIC20, and then do one of the following to browse the contents and see your compatible files:

**Carousel mode:** From the HOME screen, select the USB stick icon on the far right of the toolbar under the GAMES CAROUSEL to launch the **File loader**.



**Classic mode:** From BASIC, press  $\ominus$  then highlight and select Media access.



Both the **File loader** and **Media access** options present a list of the first 256 folders and compatible files stored in the current folder, displayed across the screen in columns. If you have just connected the USB stick, then the current folder is always the root of the USB stick.

Rather than show the filename extension (e.g. `d64`), icons appear before each file to indicate their file type. To keep the list clear and uncluttered, filename flags (explained later) are also not shown in the main files and folders list.

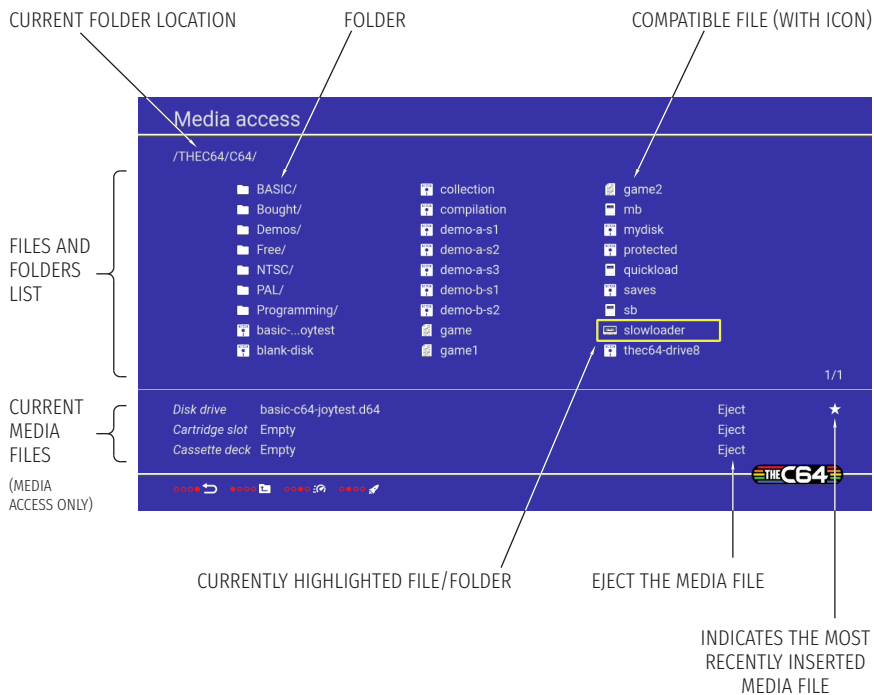

Push ←/→ to move between the columns of folders and files.

Press **(FIRE)** to open the highlighted folder and reveal its contents. If there are no further folders or compatible files, then 'No files found' displays.

To return to the previous folder, you can push ← from the first shown column, or press **(A)**.



Press **(≡)** to return to the previous screen



Press **(A)** to return to the previous folder



Press **(B)** to auto-load the highlighted file (Media access screen only)



Press **(C)** to disable/enable the fast loader, explained in detail later



If you press **(E)** at any point, you leave Media access or the File Loader screen. THEC64/THEVIC20 will remember your current location on the USB stick, so when you next select the Media access or File loader option, you return to the previously visited folder.

## AUTO-LOADING FILES FROM USB USING DEFAULT SETTINGS

Browse to and highlight a file, then press **(FIRE)** to confirm selection. In the **File loader**, this auto-loads the selected file. In **Media access**, this inserts the file if it is a virtual disk file (d64, g64, d81, d82), otherwise press **(B)** to auto-load the chosen file. See *Inserting Virtual Disks* later in this chapter for further details about inserting.

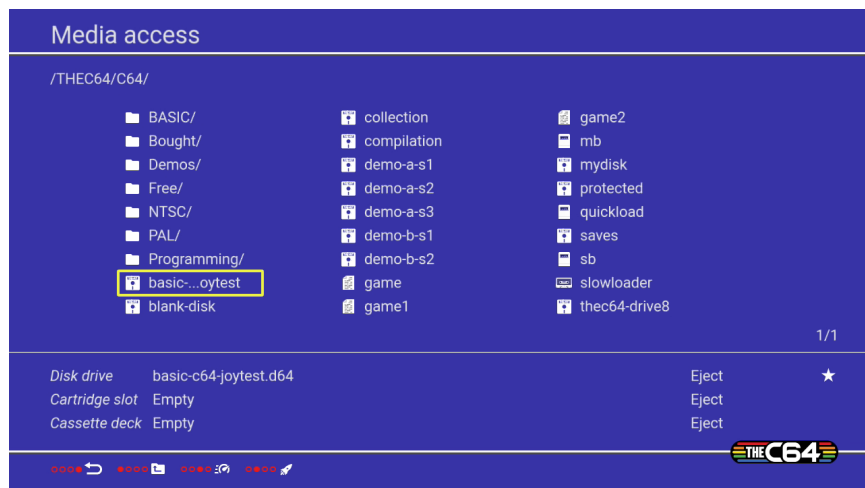

Programs loaded from a USB stick will either work using the default settings, or they will need to be customized using filename flags or CJM files, explained later.

## WHAT ARE THE DEFAULT SETTINGS?

The default settings used by THEC64/THEVIC20 relate specifically to the computer model, the joystick port and the screen settings. Loading a compatible file from a USB stick without any customization will use the following:



- the default computer model setting is used if the file is auto-loaded. If you haven't changed this, it will be set to a NTSC C64 (when Video output is set to 60 Hz) or a PAL C64 (when Video output is set to 50 Hz)
- the current computer model setting is used if a virtual disk file is first inserted (Media access only) and then loaded and run using BASIC load and run commands, explained later
- joystick port #2 is used for C64 programs (port #1 is available if a second joystick is connected) or port #1 for VIC 20 programs
- only standard functions mapped to the joystick buttons are used when running any program, i.e. ↑/↓/←/→ and **FIRE**. In addition, **A** sends a **Y** key press, **B** sends an **N** key press, **C** sends a **RETURN** key press and **≡** displays the menu
- the default screen settings are used
- the default loading options are used, including fast loader enabled and accurate disk disabled (explained later).

## SWAPPING THE DEFAULT JOYSTICK PORT

When launching a C64 program, joystick port #2 will assigned to the first (primary) joystick and port #1 to the second, if attached. This is correct for most programs, but some may expect the first primary joystick to be assigned to port #1. Changing the default port for a program can be achieved on-the-fly through a special joystick button combination or though a filename flag or a CJM file if you want that port to be remembered for the program. See **Filename Flags for Individual Files** and **CJMs for Individual Files** later in this chapter.

To connect the joystick you are holding to port #1 on-the-fly, press and hold **≡** and, while holding, press **A**. Similarly, to connect the joystick you are holding to C64 port #2, press and hold **≡** and, while holding, press **B**. Any joystick already connected to the C64 port being targeted will be moved to the other port.

THEC64 also supports additional joysticks, up to a total of four, when running C64

programs that support it. Sometimes a program will expect a joystick to be connected to port #4 instead of port #3, so you can swap ports #3 and #4 (if enabled) using the following special joystick button combination: Press and hold  on any joystick and, while holding, press . This will swap the C64 ports #3 and #4. If you invoke the button combination again, ports #3 and #4 will swap back.

Note, additional joystick support needs to be explicitly enabled using a filename flag or CJM files, and is explained later in this chapter.

## FAST LOADER

If the default settings don't work for your chosen file, then you can try one quick change with a press of a joystick button.



Whilst in **Media access** or **File loader**, disable the 'Fast loader' by pressing . The Fast Loader icon is crossed-out to indicate this. Now try loading your program again.

The Fast loader option speeds up loading times if the loading program uses the standard C64 loading routines. The moment THEC64/THEVIC20 detects a custom loader is used by a program, Fast loader disengages and THEC64/THEVIC20 uses the custom loader instead for that one program.

## LOADING FILES USING CUSTOMISED SETTINGS

**If disabling the Fast loader doesn't change the outcome and your program fails to load, then look at customization using filename flags or creating separate CJM files. A computer capable of renaming existing files, creating new text files and copying files to and from a USB stick is required before proceeding.**

Filename flags are the easiest method for customization, and apply to the file itself. If you don't need to map the joystick buttons for your program or apply the same settings to lots of files, then use filename flags.

## FILENAME FLAGS FOR INDIVIDUAL FILES

Add an underscore character `_` followed by two-character flags to the end of the filename (but before the extension type, e.g. `.d64`). These special flags tell THEC64/THEVIC20 what to do with the file. For example, `game_M6TPADJ1.d64`. The two-character flags placed after the underscore `_` can be in any order, e.g. `game_ADJ1M6TP.d64`. In this example, `M6`, `TP`, `AD` and `J1` flags have been added to the filename.

Answer the following questions about your program to learn which flags to use.

### Which computer model?

Flag	Description
M6	This sets the computer model to be a C64 (THEC64 only)
MV	This sets the computer model to be a VIC 20 (THEC64 only)
TN	This sets the computer model to be NTSC
TP	This sets the computer model to be PAL

Your program needs to use either a C64 NTSC, C64 PAL, VIC 20 NTSC or VIC 20 PAL computer model. For example, a VIC 20 program will only load and run successfully on a VIC 20 computer. It won't run on a C64 computer, and vice versa.

e.g., `vic-game_MVTN.d64` is for a virtual disk file that contains VIC 20 programs that run on an NTSC computer model. If it runs on NTSC or PAL, there's no need to specify TN or TP.

### Which joystick port?

Flag	Description
J1	This sets the primary joystick port to #1
J2	This sets the primary joystick port to #2

The only time you need to specify a joystick port using filename flags is for a C64 program that requires port 1 for the primary controller, rather than the default port 2.

Note that THEC64 will assign the other joystick port as the secondary controller by default if it detects two connected controllers. As the VIC 20 only has one port, you don't need to specify joystick ports at all using filename flags. Port 1 is assumed by default.

e.g. `c64-game_M6TPJ1.d64`

If you want to change how the joystick buttons behave when running your program, then you need to create a CJM file rather than using filename flags.

### Enable additional C64 joysticks?

Flag	Description
JA	Enable additional joysticks in user port #3 and #4

By default a C64 program will have access to the standard C64 ports #1 and #2. Some programs can make use of additional user-port joysticks as port #3 and #4. For compatibility reasons, these are not enabled by default, so if you have a program that will make use of ports #3 or #4 you can enable them by adding this flag to the filename. e.g. `my-multiport-c64-game_J1JA.d64`

Note, if you are using a CJM file for a program, additional joysticks will automatically be enabled if they are configured in the file. See **CJMs For Individual Files** later in his chapter.

### Which mouse port?

Flag	Description
P1	This specifies that joystick port #1 has a 1351 Mouse connected. A connected joystick will be moved to port #2 unless port #1 is also configured as the primary joystick port.
P2	This specifies that joystick port #2 has a 1351 Mouse connected. A connected joystick will be moved to port #1 unless port #2 is also configured as the primary joystick port (the default).

THEC64/THEVIC20 will detect when a USB mouse is connected and make it available to the running program as a Commodore 1351 Mouse connected to joystick port #1. However it may also connect a joystick to port #1, depending on the number

of joysticks attached to the USB ports and which port is specified as the primary. To alter this behaviour for a program, you can configure whether joystick port #1 or #2 is to be connected to the mouse. This configuration does not take precedence over the primary joystick port setting, but will prevent any additional joysticks from being connected to the mouse port. Therefore, if you configure the mouse to be connected to port #2 and don't want the primary joystick to also be connected to this, the default primary joystick port, then you should also configure the primary port to be #1.

### Which disk mode(s)?

Flag	Description
AD	This enables accurate disk mode (slower loading times but more accurate disk drive loading). This only applies to d64 or g64 files and could prevent other files from loading correctly.
RO	This sets the disk to be read-only (also sometimes called write-protected)
CD	This tells THEC64/THEVIC20 that the disk is part of a multi-disk set but is NOT the first disk. Saved states will then assign to the most recently inserted virtual disk file that does not have a CD flag (which should be the first disk of the set), rather than assign to this disk file.  Note that you don't have to use the CD flag for multi-disk sets, but it is useful.

Some virtual disk files (e.g. d64, g64) need the slower 'accurate disk' mode (AD) enabled before they load successfully. Some virtual disk files need to be set to 'read-only' (RO) so nothing saves back to the file. Some require both settings.

#### *Multi-disk sets*

Continuation disks (CD flag) are relevant to multi-disk programs. They are a handy way of having all saved states assign to the first disk used in the set. The first disk does NOT use a CD flag, to set it apart from any subsequent disk files in the set.

For example, we have a C64 program that uses two virtual disk files for side 1 and side 2 of the original program disk:

```
program-s1_M6ADRO.d64
program-s2_M6ADROCD.d64
```

Load and run `program-s1_M6ADRO.d64` from Media access. At some point during the program, you use the Save/load state option from the menu and save to the first slot. Later on, the program requests side 2 of the disk so you go to Media access and insert `program-s2_M6ADROCD.d64` then return to the program and follow the on-screen instructions to tell you have now swapped or flipped disks.

The program now continues. At some later point, you choose to save the state again. When you do so, the first save slot is in use from when you had the first disk inserted, and you choose to save to the second slot this time.

Later – maybe on a different day – you are in C64 BASIC and insert `program-s1_M6ADRO.d64` in Classic mode. You press  and choose save/load state without needing to load the program first. Choose to load either saved state found there and THEC64/THEVIC20 will automatically insert the correct disk and continue running the program from where it was saved.

The CD flags keeps all the saved state files associated with the first disk, and as long as the other disk files are stored in the same location as when the saved states were created, restoring them is simply a matter of inserting the first disk and loading the saved state from there.

### Which screen setting?

Flag	Description
FH	This sets the screen to full height, squeezing everything into the 720p HD image, including the top and bottom border areas

e.g. `platformer_MVTNFH.tap`

If your program looks like it is not completely in view, then you can set THEC64/THEVIC20 to display using the full height (squeezing the top and bottom borders into full view on an HD TV or monitor). Alternatively, use a CJM file to vertical shift the screen up or down without sacrificing the accurate display.

### Which VIC 20 expanded memory options?

Flag	Description
B0	This enables bank 0 of expanded memory for the VIC 20, which gives an additional 3 kB of memory. Other possible flags include B1, B2, B3, B5 and any combination of these

Some VIC 20 programs need more memory. Add expanded memory by indicating additional memory banks.

e.g. `arcade_MVTPB1B2.prg` gives the VIC 20 an additional 16 kB of expanded memory for the virtual program file to use.

See **APPENDIX C** for more details.

### Which C64 expanded memory options?

Flag	Description
R5	Enables 512 kB of REU memory
R2	Enables 2 MB of REU memory
RM	Enables 16 MB of REU memory

Some C64 software is designed to run with a RAM Expansion Unit (REU). You can enable various amounts of REU memory through the addition of these filename flags (firmware version 1.5.1 and above).

### Which miscellaneous settings?

Flag	Description
NI	This flag specifically disables the drive icon from appearing on-screen (top-right corner) during disk loading. Some programs keep the disk drive running after loading is completed, so this setting allows you to hide the drive icon so it isn't in view after loading completes
NS	This option disables Audio scaling which – when enabled – compensates for potential audio issues when programs aren't running in their native video output mode. See <b>APPENDIX D</b> for full details



You only need to consider switching off audio scale if you think the audio heard when running a program sounds wrong. Typically this setting can be left enabled (which is the default setting, so no filename flag is required).

Remember, when viewing the renamed file in the File loader or Media access, the filename flags and the filename extension are not shown, so `c64-disk_J1TNRO.d64` appears as `c64-disk`, displayed with an appropriate disk icon.

You now have the information required to go ahead and create some custom settings using filename flags.

## **CJMS FOR INDIVIDUAL FILES**

If you've not yet read the section on Filename Flags, please look at that first before reading about CJM files.

A CJM file can do almost everything that a filename flag can, but it can also define joystick buttons and apply as a default customization for multiple files.

Use the standard text editor that comes with Windows, Linux or macOS to create a CJM file.

A CJM file tells THEC64 which settings to use for a virtual media file, but unlike filename flags, a CJM file can also define joystick button functions and apply to multiple virtual files rather than just one. THEC64 always uses a CJM file in preference to any filename flags or default settings it may find. A CJM file trumps them all!

You save the CJM file in the same folder as the virtual media file on the USB stick, and give it the same filename but with a `.cjm` file extension. For example, `c64-disk.d64` has a corresponding `c64-disk.cjm` text file in the same folder. The CJM and the virtual media file must use the same filename.

Also, ensure that your CJM file ends with a `.cjm` file extension, otherwise it will not be recognized by THEC64/THEVIC20 and the settings won't be applied when the relevant program is loaded.

A CJM file's contents look like this:

```
X:64,ntsc,accuratedisk,driveicon
J:1*:JU,JD,JL,JR,JF,JF,1,2,JF,A,B,C,JF,4,5
J:2:JU,JD,JL,JR,JF,JF,F1,F2,JF,1,2,3,JF,F3,F4
V:12
```

This first example sets the computer model to a C64 NTSC, enables accurate disk mode, ensures that the drive icon is displayed in the top-right corner during disk loading, defines joystick functions for both port 1 (the primary controller in this example) and port 2. Finally, it also vertically shifts the screen up by 12 display lines to reveal more of the bottom border area of the C64's display.

```
X:vic,pal,fullheight,35k
J:1*:W,S,A,D,I,K,J,L,CT,1,2,3,,EN,4
```

The second example sets the computer to be a PAL VIC 20, using the full height of the display and giving a total memory of 35 kB to the computer. It then defines the behavior of the joystick in port 1, assigning various key presses to the directional stick and the buttons.

Each line in a CJM text file complies with the following formatting:

```
type:value[,value]
```

Refer to the following for all of the permitted entries in a CJM file.

## Computer configuration

Type:	x	Possible values:			
	64	bank0	bank1	reu512	
	vic	bank2	bank3	reu2048	
	pal	bank5		reu16384	
	ntsc				
	driveicon	3k	4k	8k	16k
	readonly	24k	32k	35k	
	accuratedisk				
	fullheight				
	noaudioscale				

This sets the parameters needed to configure the computer before it loads and runs the program.

The values are case sensitive and must be in lower case.

`64` – Specifies a C64 computer model (THEC64 only).

`vic` – Specifies a VIC 20 computer model (THEC64 only).

`pal` – This makes the program behave as though running on a European (PAL) computer. It doesn't affect the HDMI output of THEC64/THEVIC20.

`ntsc` – This makes the program behave as though running on a North American (NTSC) computer. It doesn't affect the HDMI output of THEC64/THEVIC20.

`driveicon` – This activates the on-screen drive icon, to show when a disk is accessed.

`readonly` – This makes a disk read-only, meaning THEC64/THEVIC20 cannot write back to the virtual disk.

`accuratedisk` – This switches ON accurate (slower) disk drive functionality, necessary for some programs to load correctly from a d64 or g64 file. This is off by default.

`fullheight` – This displays the full height of the computer display when running the program, sacrificing the accurate display to fit everything into the 720p image.

`noaudioscale` – This turns off the Audio scaling option, which is enabled by default.

See **APPENDIX D** for full details about the Full Height and Audio scaling options.

bank0 – Use VIC 20 expanded memory bank 0.  
bank1 – Use VIC 20 expanded memory bank 1.  
bank2 – Use VIC 20 expanded memory bank 2.  
bank3 – Use VIC 20 expanded memory bank 3.  
bank5 – Use VIC 20 expanded memory bank 5.

Note: Combine banks by stating bank1, bank2 or bank1, bank2, bank3 etc.

Alternatively, use 3k, 4k, 8k, 16k, 24k, 32k or 35k to specify directly the amount of kB of memory you want to enable. These bank settings only work with the VIC 20 computer.

See **APPENDIX C** for more details.

reu512 – Use 512 kB of C64 REU expanded memory.  
reu2048 – Use 2 MB of C64 REU expanded memory.  
reu16384 – Use 16 MB of C64 REU expanded memory.

Some C64 software is designed to run with a RAM Expansion Unit (REU). You can enable various amounts of REU memory through the use of one of the above options (firmware version 1.5.1 and above).

## Vertical display shift

**Type:** v

**Possible values:**

-15 to +17 (C64)  
-16 to +16 (VIC 20 PAL)  
-13 to 0 (VIC 20 NTSC)

This number moves the screen position up or down over a range of display lines. This is useful if a game has graphics that appear in the top or bottom border, as an HDMI 720p television screen can otherwise clip them. Alternatively, use the `fullheight` option.

For NTSC C64 programs, going above +6 could exhibit display problems at the bottom of the screen.

See **APPENDIX D** for further details about NTSC and PAL.

## Joystick configuration









**Type:** J

A CJM file can define all of the joystick functions for a program loaded from a virtual media file stored on a USB stick. You can map any key press to a function on the joystick or alternative USB controller. This includes changing the usual joystick directions ↑/↓/←/→ if need be. The only function you cannot change is the  button, which displays the menu when running a program.

**Please note that if you don't include an entry for the joystick functions within your CJM file, joysticks or alternative USB controllers will not work at all for that program even if you have the joystick or controller connected to THEC64/THEVIC20.**

You can configure up to four joysticks for the C64 (one and two are the standard joystick ports, three and four are user-port joysticks that some games support). C64 games can also support a mouse in one of the standard ports (see **Mouse** later in this chapter). VIC 20 games only allow a single joystick to be configured in port 1.

Here's the table again from **CHAPTER 2** to remind us how the joystick and an alternative USB controller compare:

<b>THEC64 Joystick</b>	<b>Alternative USB Controller</b>
↑, ↓, ←, → (DIRECTIONAL STICK)	Up, Down, Left, Right
Left  , Right 	Left Trigger, Right Trigger
 , 	Y, X
 ,  , 	A, B, Back/Guide
	Start

Define the Joystick functions in a CJM file using the following order:

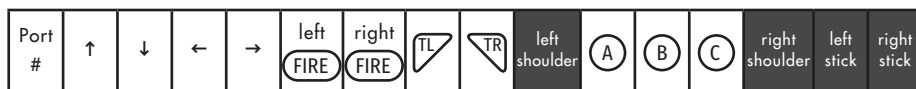

Notice the extra buttons **left shoulder**, **right shoulder**, **left stick** and **right stick**. They are not available on the joystick but are common on alternative USB controllers. The shoulder buttons are usually assigned as **FIRE** buttons. The latter two are for controllers with two sticks that press down for additional button functions. It's up to you what you map to those buttons (if anything).

For example, imagine a VIC 20 game that has no joystick controls but has keys defined to the following functions:

- |          |                    |               |                  |
|----------|--------------------|---------------|------------------|
| <b>W</b> | Move Up/Forward    | <b>CTRL</b>   | Map on/off       |
| <b>S</b> | Move Down/Backward | <b>1</b>      | Choose weapon #1 |
| <b>A</b> | Move Left          | <b>2</b>      | Choose weapon #2 |
| <b>D</b> | Move Right         | <b>3</b>      | Choose weapon #3 |
| <b>I</b> | Fire               | <b>4</b>      | Choose weapon #4 |
| <b>K</b> | Use                | <b>RETURN</b> | Select           |
| <b>J</b> | Turn Left          |               |                  |
| <b>L</b> | Turn Right         |               |                  |



















In your CJM file for that game, redefine the joystick directional stick to produce key presses, and assign other program functions to the other buttons.

A CJM text file for this VIC 20 game could therefore contain the following:

```
X:vic,pal,fullheight,35k
J:1*:W,S,A,D,I,K,J,L,CT,1,2,3,,EN,4
```

The \* indicates the primary (main) joystick port used by the program. As this is a VIC 20 program, only port #1 is available but it must still be set as the primary. In this example, we have chosen to define every button except for the right shoulder button (which isn't used by the joystick, but *is* used by some alternative USB controllers).

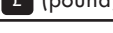
The IDs for key presses you can assign to joystick buttons are all in the following table.

ID	Key/function
JU JD JL JR JF	Joystick directions ↑/↓/←/→, and 
F1 F2 F3 F4 F5 F6 F7 F8	Function keys  to 
A B C D E F G H I J K L M N O P Q R S T U V W X Y Z 1 2 3 4 5 6 7 8 9 0	Alphanumeric keys
AL	
AU	
CM	
CO	 (comma)
CT	
CU	Cursor up
CD	Cursor down
CL	Cursor left
CR	Cursor right
DL	
EN	
HM	
RS	
RE	
SL	Left 
SR	Right 
SS	
SP	
PO	 (pound)

## Joystick Button Considerations

In all of the games provided with THEC64/THEVIC20 in Carousel mode, the left and right (FIRE) buttons have the same function (JF) so both left and right-handed players can use either button as (FIRE). However, the left and right (FIRE) buttons ARE independent, so you can assign one (FIRE) button to JF and the other to a different function if you wish in your CJM files.

In addition, for consistency all of the games on the GAMES CAROUSEL start by pressing  or by pressing a (FIRE) button. If you wish to retain this logic, keep in mind how your program starts once it has finished loading when you assign joystick buttons in the CJM file. If (FIRE) does not start the program, then assign the appropriate key press to the TL button.

## Mouse

THEC64/THEVIC20 will detect when a USB mouse is connected and make it available to the C64 as a Commodore 1351 Mouse connected to joystick port one. However it may also simultaneously connect a joystick to port one, depending on CJM or filename flag configuration. Sometimes this may not be desirable.

To tell THEC64 to connect only a mouse to port one, or to instead connect the mouse to port two, you can use a special mouse marker in the CJM joystick configuration.

```
J : 1M :
```

This specifies that joystick port one has a 1351 Mouse connected (note that the trailing colon : is required after the M). Any connected joystick will be moved to port two.

```
J : 2M :
```

This specifies that the 1351 mouse is to be connected to port two, leaving port one to have a joystick connected.



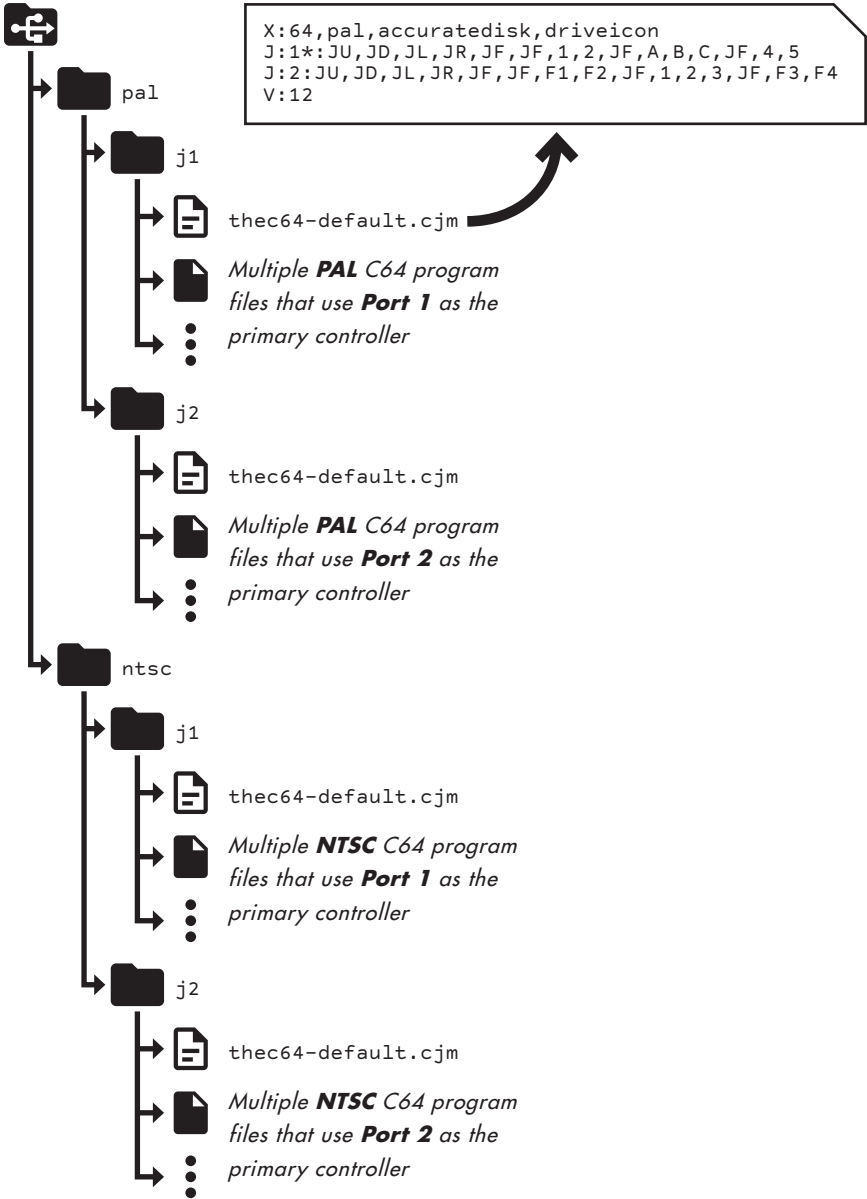

## CJMS FOR MULTIPLE FILES

THEC64/THEVIC20 can use a CJM file that applies to all files within a folder. This is particularly useful if you have multiple files that you wish to apply the exact same settings for.

Create a CJM file in exactly the same way as you would if configuring for an individual file, and place it in the relevant folder but use the special filename `thec64-default.cjm`.

If present, THEC64/THEVIC20 uses this CJM file whenever there is no file-specific CJM file present.

An important point to note is that THEC64/THEVIC20 will apply the settings in `thec64-default.cjm` file to all programs within the folder in which it is placed, even if the programs are in sub-folders.

In the example on the previous page, every program stored in the `/pal/j1/` folder will run on a C64 PAL, and use Joystick port 1 as the primary controller.

### *Structuring your files and folders on the USB stick*

The folder level configuration feature works best when you arrange your files and folders in a logical order on the USB stick, as shown in the example.

If THEC64/THEVIC20 doesn't find a `thec64-default.cjm` file in the folder, then it comes out of the current folder and looks in the parent folder instead. It continues to behave this way, working its way back up the folder structure until it reaches the root of the USB stick.

## SUMMARY

THEC64/THEVIC20 applies settings to programs loaded from a USB stick in the following order:

1. If a CJM file is present for a specific file, the CJM settings apply when the file is loaded;
2. Otherwise, if a default CJM file is present in the folder containing the program (or one of its parent folders) then those settings are applied;
3. Otherwise, any filename flags present at the end of the program filename are applied;
4. Otherwise, THEC64/THEVIC20 default settings apply.

## INSERTING VIRTUAL DISKS





If you don't want to auto-load virtual disks, then you need to be in Classic mode so you can insert virtual disks and then choose what to do next.

Inserting is essential if you plan to write and save programs to disk from BASIC or from within another program. THEC64/THEVIC20 does insert a blank disk for you if it fails to find one on the connected USB stick. A file named `thec64-drive8.d64` is automatically inserted for you, but you can easily eject it and/or insert a different disk, as explained later.

Inserting rather than auto-loading is also necessary if you wish to browse the contents, or if you need to switch (or 'flip') disks whilst running a program using a multi-disk set.

## INSERTING OR SWAPPING DISKS

Inserting a virtual disk is only possible from Classic mode using Media access.

1. Connect a suitably prepared USB stick
2. From BASIC in Classic mode, press  and select Media access
3. Highlight the virtual disk file in Media access you wish to insert and press 
4. The disk file appears in the current media section in the bottom third of the Media access screen, next to 'Disk drive' to confirm it has been inserted
5. Press  to return to the current computer.
6. If flipping or swapping disks in mid-program, follow the instructions in the currently running C64 or VIC 20 program to learn what to do next. Typically you press  or  to confirm the disk has been changed.



If you inserted a disk from BASIC without running a program first, nothing obvious has happened unless the inserted disk has filename flags, in which case those flags are automatically applied. So, if you specified a computer model or any screen settings then they take immediate effect upon your return to BASIC.

Having inserted your disk, decide what to do next on your C64 or VIC 20, e.g. browse the content, load a program and so on.

### BROWSING A VIRTUAL DISK FILE

Please note that if you currently have a BASIC program in memory, save it to disk before entering the following command. See *Save a Program* later in this section for full details.

Type a simple command in BASIC to see a directory of the inserted disk's contents.

```
LOAD "$",8
```

The number 8 is the standard device ID for the virtual disk drive used on THEC64/ THEVIC20.

Now type the following command to see what is stored on the disk. Only one drive is available to THEC64/THEVIC20.

## LIST

This command shows how much space each item uses – noted as ‘blocks’, with four blocks equaling one kilobyte (1 kB) – and how much space remains free on the disk.

```
***** COMMODORE 64 BASIC V2 *****
64K RAM SYSTEM  38911 BASIC BYTES FREE
READY.
LOAD"$.",8
SEARCHING FOR $
LOADING
READY.
LIST
0 "THEC64" "01 20"
2 "JOYTEST" PRG
662 BLOCKS FREE.
READY.
```

There are a number of different file item types that can be stored within a virtual disk. For example, PRG, SEQ, REL,USR. The main file type we are interested in is PRG. PRG files are program files that can be loaded and run directly from BASIC.

## LOADING AND RUNNING A PROGRAM FROM DISK

If you see a PRG file on a disk that you wish to load (e.g. JOYTEST), then you can type the following command to load and run the program.

```
LOAD "JOYTEST",8,1
```

The **, 1** option should cause the program to automatically run after loading, but this may not work for all programs. Some need the **RUN** command *after* the program has loaded.

Many disks load and run automatically by typing the following command without needing to see the directory first.

```
LOAD "*",8,1
```

This command loads and runs either the first file it finds on the disk OR the most recently run file (if the disk has been accessed since you launched BASIC in the same session). Typically, the main program or the main program loader runs using this command.

Enjoy using your loaded program.

## SAVING A PROGRAM TO DISK

To save a BASIC program (e.g. JOYTEST2) to the currently inserted disk, type the following command:

```
SAVE "JOYTEST2",8
```

You can verify that the program on the disk matches the program in memory by typing the following command immediately afterwards:

```
VERIFY "JOYTEST2",8
```

The C64 responds with **OK** to confirm that the program is intact on the disk. However, if you see **?VERIFYING ERROR** then the current program in memory is not the same as the program saved to disk.

There are many other BASIC commands relating to disks. Please visit the Retro Games Ltd website for links to further online resources.

## EJECTING

The current media section in Media access shows the currently inserted virtual disk, tape and cartridge (or stand-alone program file).

In Media access, push ↓ on the joystick until you enter the current media section. Now highlight the relevant **Eject** button and press **(FIRE)** to remove that file from the disk drive, the tape deck or the cartridge slot.

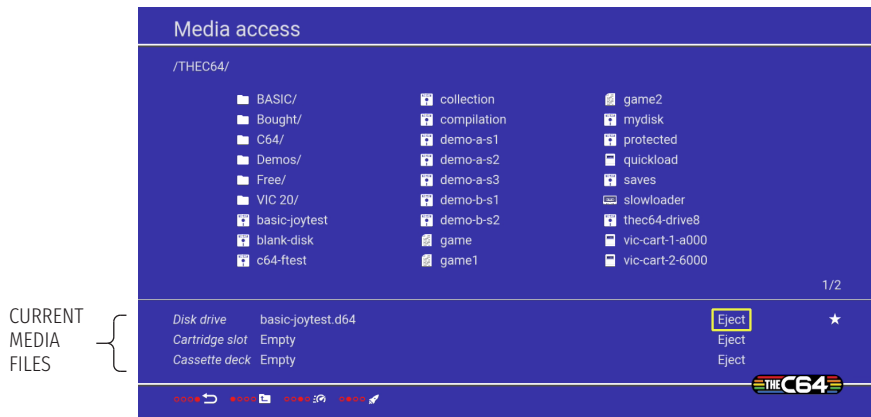

Please note that when you save your current state using the Save/load state menu option (NOT the same as saving a program to disk), the saved state assigns to the most recently inserted virtual media file. If you eject the most recently inserted file, then the previously inserted file becomes the most recent, and saved states are assigned to that file instead.

★ Note that the most recently inserted media file is shown with a star in the Current media files area.

If no virtual media file is currently inserted, then the saved state is assigned to BASIC but is still saved to the USB stick, unless the USB stick has been removed. In this scenario, the state is assigned to BASIC on THEC64/THEVIC20 itself, and that is where the saved state will be located rather than on the USB.

## USING VIRTUAL TAPE AND DATASETTE CONTROLS

Most virtual tape images contain a single loadable program, in which case auto-loading the virtual tape is the easiest means to launch the program. However, some virtual tape images contain multiple programs or a game with multi-load levels, where the game requests the user to stop and start the Datasette at various points, and even to rewind back to a certain point.

To allow this the Media Access file browser (in Classic mode) allows virtual tape images to be inserted and then navigated using play, rewind, fast-forward, stop and counter-reset Datasette controls, just like an original C64 or VIC 20 computer. The Datasette virtual tape counter can be reset to 000 at any point while the Datasette is in use by selecting the counter and pressing **FIRE**.



# CHAPTER 9

## UPGRADING

- Find Your Current Build Version
- How to Upgrade Your Firmware

Tweaks, fixes, new functionality or new content are all good reasons to upgrade the firmware to the latest version. Using THEC64/THEVIC20 should be as enjoyable as possible and the upgrades are a way to improve that experience on a semi-regular basis.

## FIND YOUR CURRENT BUILD VERSION

If you are unsure which build your THEC64/THEVIC20 is currently running, look in 'System information', which is available in both Classic and Carousel modes:

- **Classic mode** – From BASIC, press  and select 'Options', then 'Device settings' and finally 'System information'
- **Carousel mode** – From the HOME screen go to the OPTIONS (spanner) icon underneath the GAMES CAROUSEL and select 'System information'

Now look for the 'Build' information, including the 'Build date'.

Unless told otherwise on the Retro Games Ltd web site, all firmware upgrades are accumulative. This means if you have not yet upgraded, you get all of the previous upgrades within the latest firmware upgrade file.

## HOW TO UPGRADE YOUR FIRMWARE



1. Use a computer capable of browsing the Internet and copying files to a correctly formatted USB stick. See **APPENDIX B** for details about formatting USB sticks.
2. Visit **retrogames.biz/thec64** and choose Upgrade from the menu
3. Follow the links to access the latest firmware build. Check that the latest version on the website is greater than the version installed on your THEC64/THEVIC20

4. If there is a more recent firmware version on the website, download and move/copy the file (e.g. theC64-1\_3\_2.bin) to your USB stick. Don't place it inside a folder on the stick or rename the file. If you do, THEC64/THEVIC20 won't find the upgrade
5. Connect the USB stick to a USB port
6. Access 'System information' as described earlier
7. The upgrade file is detected and you are asked to close or apply
8. If you apply, then the upgrade begins
9. If you choose not to upgrade at this time, select Close, or just press 
10. After a successful upgrade, THEC64/THEVIC20 will restart automatically
11. Check the new build version by revisiting 'System information'.

**Please note that you cannot install an earlier firmware than the build version currently installed.**



# APPENDICES

## APPENDIX A

# TROUBLESHOOTING

You should always check that you are using the latest firmware by visiting the Retro Games Ltd website at [retrogames.biz/support/upgrade](http://retrogames.biz/support/upgrade). Upgrades offer improvements, enhancements and/or new functionality for THEC64/THEVIC20.

See **CHAPTER 9** for further details about how to upgrade the firmware.

Symptom	Possible cause	Remedy
Power		
Red Power LED not 'On'	THEC64/THEVIC20 is not 'On'	Single press the power switch to turn THEC64/THEVIC20 on
	Power lead not plugged in	Check power socket for loose or disconnected power lead
	Power supply not plugged in	Check wall outlet connection
	Faulty power lead	Try a different power lead

<b>Symptom</b>	<b>Possible cause</b>	<b>Remedy</b>
<b>TV output</b>		
No picture	HDMI cable not plugged in	Check appropriate HD TV/monitor and HDMI ports
	Switch-box, device or display converter between THEC64/THEVIC20 and HD TV/monitor faulty, incompatible or not configured correctly	Remove the device between THEC64/THEVIC20 and HD TV/monitor and use a direct HDMI connection
	HD TV/monitor incompatible with current refresh rate (50 Hz)	Switch on whilst pressing and holding the POWER switch for six seconds. Output is set to default 60 Hz. Specifically set the Video output option to 60 Hz when the option appears after language selection
	Faulty HDMI lead	Try a different HDMI lead
	HD TV or monitor on wrong input source	Switch input source to appropriate HDMI setting on HD TV or monitor
There is a delay between controller actions and reaction on-screen (lag)	TV is applying image processing to video output	Switch off image processing options on your HD TV, or engage 'Game mode' or equivalent on HD TV to compensate
<b>Sound</b>		
No sound	HD TV/monitor volume too low	Adjust volume of HD TV/monitor
	External speaker volume too low, or off	Turn on external speakers, adjust volume
	Amplifier or Soundbar incorrectly configured	Check the manual for your Soundbar or Amplifier

Symptom	Possible cause	Remedy
Joystick		
Joystick not working at all	Joystick not connected	Connect joystick and try again
	Joystick fault	Test joystick on a desktop or laptop computer (Windows, Linux, macOS) to verify it is working correctly
	USB port fault	Test another compatible USB device in the USB port to determine if port is faulty
	Faulty joystick	Try a different joystick
Joystick not working in a program	Joystick not correctly configured for the program	Check which joystick port the program expects the joystick to be connected to. If port 1 (for a C64 program), then this needs to be specified via filename flags or CJM files. See <b>CHAPTER 8</b> for further details
	Some programs don't require or use a Joystick	Check that your program uses a joystick. If it only uses keyboard but you want to use a joystick, create a CJM file to do this. See <b>CHAPTER 8</b> for further details.
Player One and Player Two controls have swapped over	Some two-player games on the C64 switch the joysticks, so what would be player one's joystick becomes player two's joystick in a two-player, two-joystick game and vice versa	Do not unplug and reconnect the controllers. Simply swap controllers between players.



Symptom	Possible cause	Remedy
USB stick		
File on USB stick not loading or running	File is not compatible with the current computer model	Check that the file is compatible. See <b>CHAPTER 8</b> for details about compatible files.
	File is corrupted	Obtain a fresh copy of the file from a different source
	File is incorrectly named	File might not be a compatible file type, but has been named using a recognised filename extension. File is actually incompatible and won't load.
	File is for a different computer model	Verify which computer model the file is meant to work on (e.g. a VIC 20 PRG rather than C64 PRG file)
	USB stick has read or write errors	Error-check the USB stick on a different computer or use an alternative stick
	THEC64 is not receiving sufficient power	Use a powered USB hub or detach other USB devices from hub
<b>LOAD</b> "\$", 8 from BASIC, shows the disk name is <b>READ</b> <b>ONLY</b> and the disk cannot be written to	USB stick is not detected	See <i>USB stick not detected</i> in this appendix

Symptom	Possible cause	Remedy
USB stick detected but can't be accessed	Stick not formatted to FAT32 with Master Boot Record (MBR)	Format stick following advice in <b>APPENDIX B</b>
USB stick not detected	Stick not connected	Connect USB stick to a USB port before selecting Media access (Classic mode) or whilst on HOME screen (Carousel mode)
	Stick not formatted to FAT32 with Master Boot Record (MBR)	Format stick following advice in <b>APPENDIX B</b>
	Stick connected via unpowered USB hub so is not receiving sufficient power	Use a powered USB hub or detach other USB devices from hub
VIC 20 program file (.prg) fails to load	This file could be for a C64 rather than a VIC 20	Try loading the file on a C64 computer model
Program display		
Program display is cut off at the top or bottom of the screen	The current program uses the top and/or bottom border areas of the screen	Use either the fullheight or Vertical display shift CJM settings, or FH filename flag to reduce or remove this effect. See <b>CHAPTER 8</b> for details

Symptom	Possible cause	Remedy
Virtual disk		
BASIC reports <b>?FILE NOT FOUND ERROR</b> when trying to access a disk	No disk has been inserted and/ or the current disk has been ejected	Insert a disk using 'Media access'
	File is not compatible with the current computer model	Check that the file is compatible. See <b>CHAPTER 8</b> for details
	Disk is using the AD (accuratedisk) setting but file is NOT a d64/g64 file	d71 or d82 virtual disk files don't need AD (accuratedisk) settings enabled, and will fail to load if they are. See <b>CHAPTER 8</b> for details
Disk begins to load then fails to complete loading	Disk needs to have additional settings using filename flags or CJM file	Typically, some disks only load successfully if AD (accuratedisk) and/or RO (readOnly) are applied. See <b>CHAPTER 8</b> for details
Tape file fails to complete loading	Some tape files take a long time to load and do not give any sign of progress on-screen during the loading process	Patience is a virtue. Wait a while longer before assuming the tape file isn't loading
Virtual cartridge		
VIC 20 cartridge file fails to load and only shows BASIC	The cartridge file is for a C64, not the VIC 20	Try loading the file on a C64 computer model
	The cartridge file is one of a set and does not load on its own (Classic mode only)	Try auto-loading the next cartridge file in the set (Classic mode only) and see if the VIC 20 cartridge program then runs
	The cartridge file needs additional settings using filename flags	Check what the cartridge expanded memory requirements are on the VIC 20. See <b>CHAPTER 8</b> for further details

Symptom	Possible cause	Remedy
Saved states		
Saved states for programs loaded from USB are not available when the relevant virtual media file is inserted later	Before the states were saved, the relevant virtual media file (tape, disk, cartridge, etc.) was ejected or replaced in Media access with a different file	Saved states associate with the last inserted virtual media file. If you eject a file from Media access, saved states associate to the most recently and currently inserted file shown in media access until a new file is inserted. If no files are currently inserted, saved states associate with BASIC instead
	Before the states were saved, the relevant USB stick was removed or no longer detected	The saves are accessible from BASIC when no USB stick is connected
VIC 20		
VIC 20 program displays in the top-left corner of the screen	The current program needs to run on a VIC 20 NTSC, but is currently running on a VIC 20 PAL computer model	Switch the current model to a VIC 20 NTSC, or customize the file so it runs on a VIC 20 NTSC computer using filename flags or cjm files. See <b>CHAPTER 8</b> for details
VIC 20 program file (.prg) fails to load	This file could be a VIC 20 cartridge program	Rename the file from .prg to .crt and try loading it again

Please visit [retrogames.biz/support](https://retrogames.biz/support) for additional troubleshooting advice.

## APPENDIX B

# PREPARING USB STICKS

Upgrading the firmware, running other program files or saving and loading programs in BASIC all require a USB stick, formatted using FAT32 with MBR (Master Boot Record).

With most formatting utilities, MBR isn't explicitly stated as an option so it isn't immediately obvious if your USB stick has it or not.

## THE USB FORMATTING PROCESS

You must format your USB stick on a suitable computer before connecting it to THEC64/THEVIC20. Most computer operating systems (typically Windows, Linux or macOS) have an in-built tool for formatting a USB stick to the required standard.

Firstly, choose a USB stick that you are happy to wipe clean of all files and folders. Connect your chosen USB stick to the computer intended for formatting the stick. What you do next depends on which operating system is running on the computer.

### WINDOWS 10/8/7 (USB STICK CAPACITY UP TO 32 GB)

If a window doesn't automatically display the content of the USB stick after connection, press  + E to open File Explorer.

1. In File Explorer, right-click over the drive icon for the USB stick you want to use. Please ensure that you have selected the correct device before you proceed any further!
2. Select Format In the 'File System' category, and then select FAT32 (Default). Note that Windows will not offer to format a USB stick using FAT32 if the capacity (size) of the partition is greater than 32 GB.

3. We recommend that you don't tick the 'Quick Format' option. As a result, the format will take longer, but it checks for errors on the stick as part of the formatting process. Also, not using 'Quick format' ensures that MBR will apply
4. Select 'Start' to begin.

In Windows 10, you can check for MBR after formatting is complete:

5. Right-click over the USB stick in Windows Explorer
6. Select 'Properties' from the bottom of the menu
7. Select the 'Hardware' tab
8. Select your USB device from the list
9. Select the 'Properties' button
10. Select 'Volumes' tab
11. Select 'Populate'
12. Select 'Volumes' tab (again)
13. Select 'Populate' (again)

For earlier versions of Windows (e.g. Windows XP/2000/NT4), you will need to source a separate utility that can format FAT32 with MBR. Use your preferred search engine to find one online.

## **MACOS**

The following instructions apply to High Sierra (10.13.6), but we cannot guarantee that they apply to all releases of macOS.

1. After connecting the USB stick, a USB icon appears on the desktop. Now run Finder.
2. Select Applications > Utilities > Disk Utility, then select your USB stick. Please ensure that you have selected the correct device before you proceed!
3. Select the 'Erase' option. You can 'Name' the USB stick if you like
4. Select 'FAT32' or 'FAT' from the Format menu. If FAT32 is grayed out, select FAT instead. As far as this process is concerned, they achieve the same result
5. Finally, select the 'Erase' button to begin the formatting process.

Note that unlike Windows, macOS will format a 64 GB USB stick using FAT32.

## LINUX

You need to know the root password for your Linux computer before you can format your USB stick using the guidance below.

1. The quickest and simplest method for Linux users to format a USB stick is to open a new terminal session and enter the `df` command
2. All available storage devices are now listed, but the only one that is of interest to you is the USB stick
3. Determine which item in the list is your USB stick. Please ensure that you have identified the correct device before you proceed!
4. We are using the example of `/dev/sdb1` in the remaining instructions. Just substitute this with your own if it is different
5. Type `umount /dev/sdb1` and press Return. This unmounts the USB stick, ready for formatting by the next command
6. Now type `sudo mkfs.fat -F32 -v -I -n THEC64 /dev/sdb1` and press Return. Note that the name of the stick ("THEC64") is just an example. Use another name, or just omit the `'-n THEC64'` to not name the USB stick
7. Supply your root password and then the formatting will begin.

You now have a FAT32 formatted USB stick with MBR (Master Boot Record) ready to be used for:

- copying compatible C64 program files onto the USB stick and running them using the Media access function
- saving and loading programs written for use in BASIC
- copying an official firmware upgrade file onto the root of the stick and upgrading THEC64 firmware (assuming the upgrade file is more recent than your installed firmware build)

## APPENDIX C

# VIC 20 COMPUTER

A VIC 20 computer model is available on THEC64. The VIC 20 is the predecessor to the C64. The C64 and the VIC 20 share the same keyboard on THEC64, and the same commands work on both computers for loading, saving and verifying programs on disk.

However, the VIC 20 differs in a number of other ways. The most obvious differences are in its video and audio capabilities and the amount of memory available. The C64 only runs C64 programs, and the VIC 20 only runs VIC 20 programs.

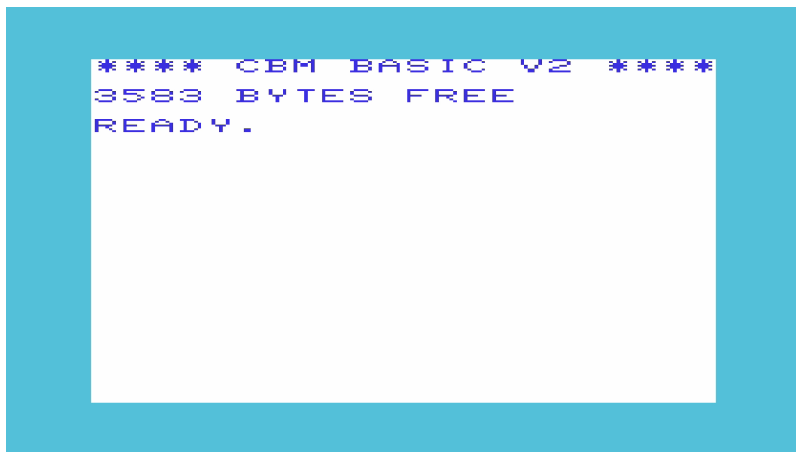

In Classic mode, press , select Options then Device settings > Computer model, and choose a VIC 20 model (PAL or NTSC) as the current computer.

In Classic or Carousel mode, you can also choose to make the VIC 20 the default computer model when THEC64 boots to Classic mode. In Carousel mode, select the Options (spanner) icon on the HOME screen then select Computer model and choose VIC 20 (PAL or NTSC).



To access a VIC 20 in Carousel mode you either play the VIC 20 games available from the CAROUSEL, or run a program from USB stick (using the File loader) that specifies a VIC 20 via either filename flags or a CJM file.

To access a VIC 20 in Classic mode, run a program from USB stick (using the Media access menu option) that specifies a VIC 20 via either filename flags or a CJM file.

## MEMORY OPTIONS

The original VIC 20 model has 3,583 bytes free from BASIC V2. Some VIC 20 programs require more memory, so THEC64 has the ability to expand the memory using filename flags and CJM files, using combinations of expanded memory banks.

The typical combinations of expanded memory banks needed for some VIC 20 programs are:

Bank combination(s)	Use for
0	Programs requiring 3 kB of additional expanded memory
1	Programs requiring 8 kB of additional expanded memory
1,2	Programs requiring 16 kB of additional expanded memory
1,2,3	Programs requiring 24 kB of additional expanded memory
1,2,3,5	Programs requiring 32 kB of additional expanded memory
0,1,2,3,5	Programs requiring 35 kB of additional expanded memory

Note that some programs only run on an unexpanded VIC 20 with the standard 3,583 bytes free from BASIC and do not work at all if any expanded memory is set.

To specify your expanded memory requirements for a specific VIC 20 program, add these values as filename flags or include them in a relevant CJM file, e.g. `_B1B2` for

VIC 20 programs that need an extra 16 kB, or `bank1`, `bank2` added to the `x:` line in a CJM file (or the alternative 16k alias).

All USB devices work with the VIC 20 computer model as they do on the C64. However, the VIC 20 only has one joystick port, so only one controller is ever required.

## CARTRIDGE FILES

Many of the virtual cartridge files for the VIC 20 are available as program (`prg`) files. For these to run correctly on THEC64, they must be renamed as cartridge (`crt`) files.

Some virtual cartridge files for the VIC 20 are large and are split into separate files that need to load into different memory locations (addresses) before they can run. THEC64 evaluates the memory address requirements for each file automatically, so you don't need to worry about the addresses.

To load a VIC 20 cartridge file (`crt`) that is split into multiple files, switch to Classic mode and then auto-load each one in turn on a VIC 20 computer model. If one cartridge file uses address A000 then load that last. When the final file is loaded, the program will run.

If required, each file should have filename flags or an appropriate CJM file to set the required amount of memory, set the computer model and so on.

e.g. auto-load `game-part-1_MVB1B2FH.crt` using Media access and then auto-load `game-part-2_MVB1B2FH.crt` immediately afterwards. It doesn't matter in which order the files are loaded unless you know one of the files uses address A000, which auto-runs the program and so should be loaded last in the sequence.

You cannot load multi-file VIC 20 cartridges in Carousel mode. You have to use Media access in Classic mode.

## JOYSTICK PORT

The VIC 20 only has one joystick port, referred to as port 1. The joystick or controller that uses that port is referred to as J1. If you decide to create a CJM file for any VIC 20 programs, make sure you set the primary port to be J1 within that file. Without that setting specified, the joystick won't work at all because you haven't made port 1 available to the program.

If you don't include joystick settings as part of any filename flags for a VIC 20 program, THEC64 will make port 1 available to the VIC 20 by default.

## SCREEN SETTINGS

Some VIC 20 programs use the very top and/or bottom areas of the screen display, which are not usually in full view when displayed by THEC64 using the default settings.

If a running VIC 20 program looks like it is missing something at the bottom or top of the screen, then use the special full height setting that squeezes the entire display into the 720p image generated by THEC64. Add `FH` as a filename flag or add `fullheight` to the `X` entity in the relevant CJM file.

If a VIC 20 program appears in the top-left corner of the screen rather than in the center, then chances are you are running a VIC 20 PAL but the program requires a VIC 20 NTSC computer model, or vice versa. Change the model manually, or set some appropriate customization and then run the program again.

Some VIC 20 programs also let you move the screen position by pressing the **CRSR** keys on the keyboard, with or without holding down the **SHIFT** key. Other programs might use the joystick to achieve the same result. Perform these changes after loading the program from a USB stick.

See **CHAPTER 8** for further details about filename flags and CJM files.

## APPENDIX D

# ADVANCED SETTINGS

There are some settings on THEC64/THEVIC20 that are a little more advanced in regards to what they do. These include Video output, Audio scaling and NTSC or PAL computer model settings. Read this appendix when you can't get a program to run the way you think it should be.

## 60 HZ OR 50 HZ

If your connected HD display can accept a 50 Hz image, you will see Video output settings during the initial set up process for THEC64. You can choose between 60 Hz (the default) or 50 Hz.

If your current HD TV or monitor can display a 50 Hz signal, then Video output options appear when you first switch on THEC64/THEVIC20 as part of the initial set up. If your HD TV or monitor cannot display at 50 Hz, then this screen does not appear and THEC64/THEVIC20 automatically uses 60 Hz.

## WHY CHANGE THIS SETTING?

An original North American C64 or VIC 20 computer outputs at a refresh rate slightly less than 60 Hz. A European C64 or VIC 20 outputs at a rate slightly more than 50 Hz.

In comparison, THEC64/THEVIC20 locks to the HDMI rate of exactly 50 Hz or 60 Hz depending on the Video output setting, so that it produces super-smooth and tear-free graphics when running programs on a modern HD display. Regardless of the video output setting, THEC64/THEVIC20 ensures that programs believe they are running at original C64 PAL or C64 NTSC speeds, as appropriate.

A C64 PAL computer will run faster when the Video output is set to 60 Hz. An NTSC C64 computer will run slower when the Video output is set to 50 Hz. As you would expect, a C64 PAL computer runs at almost exactly the right speed when the output is set to 50 Hz, as will an C64 NTSC computer when the output is set to 60 Hz. This is their native mode.

<b>Computer</b>	<b>Video output</b>	<b>Speed</b>
C64 PAL	50 Hz	About right
C64 NTSC	50 Hz	Slower
C64 PAL	60 Hz	Faster
C64 NTSC	60 Hz	About right

The pre-installed C64 games available in Carousel mode run on a mixture of NTSC and PAL C64 and VIC 20 computers without you having to change anything. The type of computer that launches a program from the Media access function or from BASIC in Classic mode also varies based on a number of different settings, but again they are either running on a PAL or an NTSC computer model.

What this means is that some programs will run faster and some will run slower depending upon the current video output setting and the type of computer model in use.

For some programs, the increase or decrease in speed only makes a superficial difference. For others, the difference is a little more obvious, especially in regards to the pitch of the audio on the running program.

To compensate, THEC64/THEVIC20 applies some automatic adjustments to make the pitch of the audio as close to the original experience as possible when a program is not running in its native mode. This is called Audio Scaling.

## **AUDIO SCALING**

By default, THEC64 automatically applies an audio scaling algorithm when a program is running. This dynamically calculates the required audio shift based on the current Video output mode, the running program, the computer model in use (NTSC or PAL) and the speed of the original computer model.

This option attempts to make the audio shift sound correct even when the program is running at an increased or decreased speed.

You can disable this option using filename flags or CJM files. To disable audio scale, use `noaudioscale` in a CJM file or `NS` as a filename flag. It is not expected that you will need to disable this option very often when running other programs on THEC64/THEVIC20.

## NTSC OR PAL

The main area of THEC64/THEVIC20 display (the dark blue area in BASIC on a C64) is pixel-for-pixel the same size for both a NTSC and a PAL computer. A light blue border (in C64 BASIC) surrounds this main area, and this border is vertically smaller (has less display lines) on an NTSC computer than on a PAL computer.

The amount of the border that your TV displays can also vary from one TV to another, due to a technical feature called overscan. This means that a varying amount of the border is hidden from view.

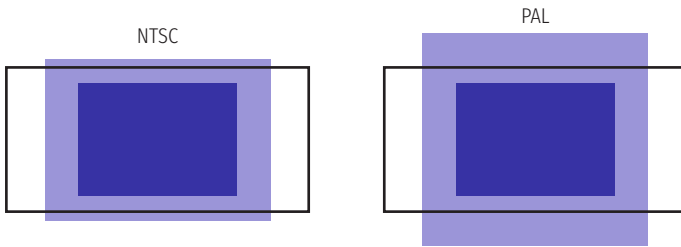

None of these facts are really significant on THEC64/THEVIC20 unless a running C64 program uses the border area to display additional information.

## VERTICAL SHIFT

By creating a CJM text file for use with a program loaded from a USB stick, you can set a vertical shift value that moves the middle area of the screen up or down by a certain number of lines to reveal more of the hidden portion of the top or bottom border area.

For example, if a game uses the bottom horizontal border to add a game critical display panel, then you can move the central area up the screen to reveal more of the display panel.

You can adjust the vertical position up or down using values of  $-15$  (moving the main central area down) to  $+17$  (moving the area up) for a C64,  $-16$  to  $+16$  for VIC 20 PAL, or  $-13$  to  $0$  for VIC 20 NTSC, by adding this to a CJM text file.



Un-shifted display (PAL C64)



Vertical Shift +12 (PAL C64)

However, using the vertical shift value on a program running on an NTSC C64 computer can cause a problem if you have a vertical shift value of more than +6 in your CJM file. You are likely to see odd graphical issues appearing in the bottom few lines of the display as you reveal an area that is beyond the NTSC C64's border. For this reason, not many NTSC C64 programs use the borders and if they do, they tend to only use a few of the lines in the border area.

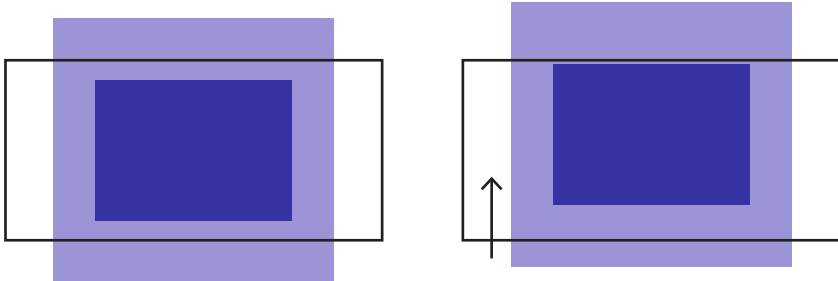

See **CHAPTER 7** for further details on all of the options and settings. See **CHAPTER 8** for further details about filename flags and CJM files.

## FULL HEIGHT

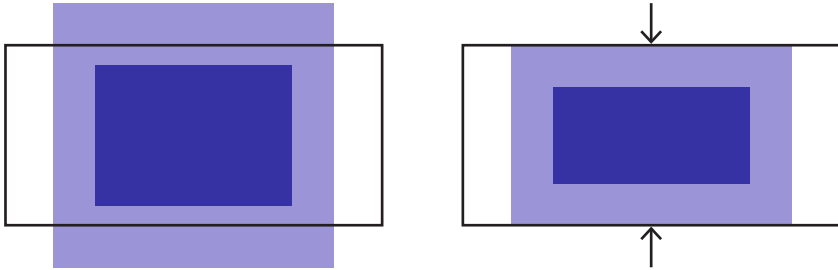

The `FH` filename flag or `fullheight` CJM setting makes THEC64/THEVIC20 display the full height of the computer's display when running a program, sacrificing the accurate display to fit everything into the 720p image.

So, instead of moving the display up or down using vertical shift, you instead squash the display and fit it into the 720p image, catering for the top and bottom borders becoming visible but at the expense of introducing some occasional odd visual artifacts.



## RESETTING THE COMPUTER IN CLASSIC MODE

When in Classic mode, the computer model may be reset by selecting Reset Computer from the Options menu, which performs a hard reset by simulating turning the computer off and back on. Alternatively the computer model may be reset with a finer level of control by using a number of hot-key combinations (available since firmware version 1.4.2):

Key combination	Action
Left <b>SHIFT</b> +  /  + Power Button	Hard Reset: Simulates cycling the computers power off and on.
Left <b>SHIFT</b> + Power Button	Soft Reset: Causes the computer model to enter its restart sequence. Does not simulate a power cycle and maintains memory contents. This is useful for applying POKEs.
Right <b>SHIFT</b> + Power Button	Cartridge Freeze button: If a virtual cartridge has been inserted which supports a Freeze Button, such as the Super Snapshot cartridge, this hot-key sequence activates that feature by simulating the pressing of the cartridge freeze button.



## APPENDIX E

# JOYSTICK BUTTON ASSIGNMENTS

The joystick has a number of different functions assigned to the buttons depending on where you are within THEC64/THEVIC20 screens.

Below is a list of functions and a brief description of their use:



Press **(≡)** to return to the previous screen



Press **(A)** to return to the previous folder



Press **(A)** to re-sort the GAMES CAROUSEL



Press **(A)** to save the current state



Press **(B)** to Auto-load the highlighted file



Press **(C)** to disable/enable the fast loader



Press **(C)** to load the highlighted saved state



Press **(C)** to disable/enable the menu music

For all other actions, highlight the selectable option shown on-screen and press **(FIRE)** to select.

**RETRO  
GAMES  
LTD**